



BODY & PAINTSHOP, TIRESHOP

HEDSON TECHNOLOGIES

One company - three brands,
Hedson Technologies offers you sustainable
solutions for all your needs in the workshop.

With user experience in focus and based on innovative
technology, all Hedson brands and products have one thing
in common - to deliver technical solutions that meet the high
demands of professional customers.

Hedson offers sustainable, durable and easy to use products
for all areas and sizes of workshops.

ORIGINAL INNOVATORS, FOUNDED IN:

1967 IRT

- High quality curing
Infrared
UV-A LED
- Handheld
- Mobile
- Fixed installations
- Fast and precise
- Save energy
- Optimise workflow
- Save time

1974 HERKULES

- Pneumatic lifts
Lift on chassis
Lift on wheels
Duo function
- Durable
- Clean
- In ground
- On ground
- For prep area
- For spray booth

1978 DRESTER

- Spray gun cleaners
- Durable pumps
For water
For solvent
Combi systems
- Wheel Washers
Durable pumps
Smart user interface
- Integrated recycling





All Hedson original products are designed, developed and assembled in Sweden and Germany.



IRT CURING EQUIPMENT

Save space, time and money

A wide selection of high-quality, user-friendly, space saving short-wave infrared (IR) and ultraviolet (UV-A) IRT dryers.

A combination of 50+ years of curing know-how, high-end parts, sophisticated software and inhouse/third party/user tests will cure your material 100%, every time.

IRT mobiles and rail dryers provide reliable, high quality results with advanced curing technology that is easy to use. They are designed for the workshop, to save floor space and speed up the repair job process.

IRT provides maximum productivity in the body shop, always considering health and safety regulations.

- Controlled heat distribution
- Large curing areas
- Short curing times

IR CURING, DRY IN MINUTES

IRT IR dryers use gold coated reflectors for superior heat transfer management.

UV-A CURING, DRY IN SECONDS

IRT UV-A dryers have an outstanding intensity, developed in cooperation with market leading paint manufacturers.

IF YOU WANT IT ALL

The combination of IR and UV-A curing makes our IRT COMBI range unique.

Gold coated reflectors	Infrared	Ultraviolet UV-A	Ultraviolet UV-A LED	Wear UV safety glasses	Powerful ventilation	Mobile dryer	Rail dryer	Distance control for preset programs	Non-contact temp. monitor	Battery operated	Cord operated	Handheld



IRT INFRARED CURING

Careful consideration of bodyshop heating requirements

To provide the best heat transfer possible, all IRT infrared (IR) dryers are equipped with unique gold coated reflectors.

IRT reflectors provide a superior heat distribution and a large curing area. Short-wave IR provides full heat immediately and penetrates deep into the paint. The paint cures from the inside and out without retaining solvents and moisture.

Heat loss to the air is minimal and all energy is transferred to the surface. IRT IR dryers irradiate the object and do not heat the surrounding air, thereby minimizing energy losses.

- Efficient use of energy
- Short drying times
- Large curing area
- High quality curing results



ADVANCED AUTOMATIC DISTANCE AND TEMPERATURE CONTROL.

Look for these symbols for temperature measurement (pyrometer), laser circle and digital distance sensor. The surface temperature is continuously measured and the effective output regulated in a split second for optimal curing results.

IRT CURING TIMES	
Putty	5-6 min
Filler, bright/dark	7-15 min
Water based paint	4-6 min
Base coat	4-8 min
Top/clear coat, plastic filler	4-15 min
Plastic top/clear coat, soft cure	5-17 min
Final boost	2-4 min

The curing time is extremely short. Times above apply to the PcAuto range. Add a minute or two for other models.

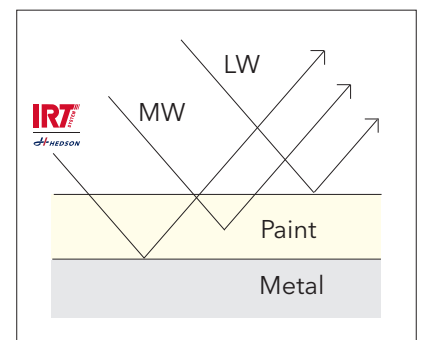

SIMPLIFIED DIAGRAM
Short-wave heat cures from the inside and out without retaining solvents and moisture.



IRT 1

Use handheld or attach to a stand (optional), for minor paint and panel work

- One lamp - output power 1 kW
- Gold coated reflector
- Best curing at 30 cm from the surface

DIMENSIONS

Handheld (LxHxD)	418x196x66 mm
Handheld weight	1,8 kg
Stand (HxW)	1450x350 mm
Stand weight	10 kg
Curing area*	0,17 m ²

* Curing area at a distance of 30 cm

IRT 1 PREPCURE, HANDHELD

Part no.	Current	Output power	Fuse	Voltage	Frequency
800429	4 A	1 kW	10 A	230V, 1 PH, EU	50-60 Hz
800624	4 A	1 kW	10 A	230V, 1 PH, UK (UK plug)	50-60 Hz
800431	4 A	1 kW	10 A	230V, 1 PH, AUS & ARG type 1	50-60 Hz
800432	9 A	1 kW	15 A	100V, 1 PH, JP	50-60 Hz
800428	9 A	1 kW	15 A	110V, 1 PH, NA (not ETL)	50-60 Hz
800524	9 A	1 kW	15 A	110V, 1 PH, NA ETL (fixed on stand - no timer)	50-60 Hz

STAND FOR IRT 1

Part no.	Voltage	
800460	230V, 1PH, EU	Stand with timer
800598	-	Stand without timer



IRT 2

Use handheld or attach to a stand (optional), for minor paint and panel work

- Two lamps - output power 2 kW
- Gold coated reflectors
- Best curing at 40-60 cm from the surface

DIMENSIONS

Handheld (LxHxD)	411x206x147 mm
Handheld weight	2,8 kg
Stand (HxW)	1450x350 mm
Stand weight	10 kg
Curing area*	0,44 m ²

* Curing area at a distance of 60 cm

IRT 2 PREPCURE, HANDHELD

Part no.	Current	Output power	Fuse	Voltage	Frequency
800433	9 A	2 kW	13 A	230V, 1 PH, EU	50-60 Hz
800625	9 A	2 kW	13 A	230V, 1 PH, UK (UK plug)	50-60 Hz
800472	9 A	2 kW	13 A	230V, 1 PH, AUS & ARG type 1	50-60 Hz
800434	9 A	2 kW	15 A	240V, 1 PH, NA ETL (fixed on stand - no timer)	50-60 Hz

STAND FOR IRT 2

Part no.	Voltage	
800460	230V, 1PH, EU	Stand with timer
800598	-	Stand without timer





IRT 3

Dryer adjustable in vertical position

- One cassette with 3 IR lamps
- Digital timers - flash off/full bake 30 + 30 minutes
- Settings will remain after power off

DIMENSIONS

Stand height	1531 mm
Cassette vertical range (height)	88-1300 mm
Width	694 mm
Weight	23 kg
Curing area*	1,0 x 1,1 m

* Curing area at a distance of 60 cm, on black sheet metal

IRT 3 PREPCURE

Part no.	Current	Output power	Fuse	Voltage	Frequency
800610	13 A	3 kW	16 A	230V, 1 PH, EU	50-60 Hz
800473	13 A	3 kW	13 A	230V, 1 PH, UK (UK plug)	50-60 Hz
800474	13 A	3 kW	16 A	230V, 1 PH, AUS & ARG type 1	50-60 Hz
800612	13 A	3 kW	20 A	230V, 1 PH, NA ETL	50-60 Hz



IRT 4

Dryer adjustable in both vertical and horizontal positions

- One cassette with 3 IR lamps, max height 2150 mm
- Digital timers - flash off/full bake 30 + 30 minutes
- Settings will remain after power off

DIMENSIONS

Stand height	1574 mm
Cassette vertical range (height)	160-2150 mm
Width	1188 mm
Weight	46 kg
Curing area*	1,0 x 1,1 m

* Curing area at a distance of 60 cm, on black sheet metal

IRT 4 PREPCURE

Part no.	Current	Output power	Fuse	Voltage	Frequency
800611	13 A	3 kW	16 A	230V, 1 PH, EU	50-60 Hz
800443	13 A	3 kW	13 A	230V, 1 PH, UK (UK plug)	50-60 Hz
800617	13 A	3 kW	16 A	230V, 1 PH, AUS & ARG type 1	50-60 Hz
800615	13 A	3 kW	20 A	230V, 1 PH, NA ETL	50-60 Hz





IRT 3-1

Standard dryer with process control

- One cassette with 3 IR lamps
- Computerized curing process, 12 preset and 3 custom programs
- Electronic distance sensor signals correct distance to curing surface

DIMENSIONS

Stand height	1435 mm
Cassette vertical range (height)	80-2550 mm
Width	1230 mm
Weight	53 kg
Curing area*	1,0 x 1,1 m

* Curing area at a distance of 60 cm, on black sheet metal

IRT 3-1 PCD

Part no.	Current	Output power	Fuse	Voltage	Part no.
800450	4 A	3 kW	10 A	400V, 3 PH, 4-pin, EU	50-60 Hz
800451	4 A	3 kW	10 A	400V, 3 PH, 5-pin, EU	50-60 Hz
800447	8 A	3 kW	10 A	230V, 3 PH, EU	50-60 Hz
800483	4 A	3 kW	10 A	400V, 3 PH, AUS	50-60 Hz
800467	13 A	3 kW	20 A	230V, 1 PH, NA ETL	50-60 Hz



IRT 3-2

Efficient curing for all types of paint materials

- Two cassettes - each with 3 IR lamps
- Computerized curing process, 12 preset and 3 custom programs
- Electronic distance sensor signals correct distance to curing surface

DIMENSIONS

Stand height	1435 mm
Cassette vertical range (height)	80-2550 mm
Width	1230 mm
Weight	62 kg
Curing area*	2,0 x 1,1 m

* Curing area at a distance of 60 cm, on black sheet metal

IRT 3-2 PCD

Part no.	Current	Output power	Fuse	Voltage	Frequency
800453	9 A	6 kW	16 A	400V, 3 PH, 4-pin, EU	50-60 Hz
800454	9 A	6 kW	16 A	400V, 3 PH, 5-pin, EU	50-60 Hz
800459	15 A	6 kW	16 A	230V, 3 PH, EU	50-60 Hz
800455	9 A	6 kW	16 A	400V, 3 PH, AUS	50-60 Hz
800484	15 A	6 kW	16 A	200V, 3 PH, 4P, JP	50-60 Hz
800458	26 A	6 kW	30 A	230V, 1 PH, NA ETL	50-60 Hz





ADVANCED AUTOMATIC DISTANCE AND TEMPERATURE CONTROL:

Pyrometer temperature measurement with laser circle indicator and digital distance sensor. The surface temperature is continuously measured and the effective output regulated in a split second for optimal curing results. Also allows for 3-step drying cycles.

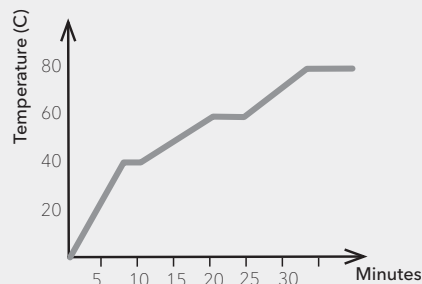

Example of a 3-step drying cycle, used for panel bonding and construction glues etc.



IRT 4-1 & 4-2 PCAUTO

High output dryer, easy to use with advanced curing technology, up to 110°C/230°F

- Automatic temperature control and distance measuring
- 15 process programs (3 customizable)
- Laser circle indicates where temperature measuring takes place
- Electronic distance sensor signals correct distance to curing surface

DIMENSIONS	IRT 4-1	IRT 4-2
Stand height	1450 mm	1450 mm
Cassette vertical range (height)	80-2500 mm	80-2500 mm
Width	1230 mm	1230 mm
Weight	53 kg	62 kg
Curing area*	1,1 x 1,5 m	2,2 x 1,5 m

*Curing area at a distance of 60 cm, on black sheet metal



IRT 4-1 PCAUTO

Part no.	Current	Output power	Fuse	Voltage	Frequency
800423	9 A	6 kW	10 A	400V, 3 PH, 4-pin, EU	50-60 Hz
800425	9 A	6 kW	10 A	400V, 3 PH, 5-pin, EU	50-60 Hz
800421	15 A	6 kW	16 A	230V, 3 PH, EU	50-60 Hz
800426	9 A	6 kW	10 A	400V, 3 PH, AUS	50-60 Hz
800485	15 A	6 kW	16 A	200V, 3 PH, 4P, JP	50-60 Hz
800422	26 A	6 kW	30 A	230V, 1 PH, NA ETL	50-60 Hz
800468	15 A	6 kW	16 A	230V, 3 PH, NA ETL	50-60 Hz
800427	9 A	6 kW	10 A	400V, 3 PH, AUS	50-60 Hz
800613	13 A	6 kW	20 A	440-480V, 2PH, 3P, NA ETL	50-60 Hz

IRT 4-2 PCAUTO

Part no.	Current	Output power	Fuse	Voltage	Frequency
800418	16 A	12 kW	16 A	400V, 3 PH, 4-pin, EU	50-60 Hz
800400	16 A	12 kW	16 A	400V, 3 PH, 5-pin, EU	50-60 Hz
800413	30 A	12 kW	32 A	230V, 3 PH, EU	50-60 Hz
800415	30 A	12 kW	32 A	200V, 3 PH, 4P, JP	50-60 Hz
800417	16 A	12 kW	16 A	400V, 3 PH, AUS	50-60 Hz
800411	48 A	12 kW	50 A	230V, 1 PH, NA ETL	50-60 Hz
800414	30 A	12 kW	30 A	230V, 3 PH, NA ETL	50-60 Hz
800419	16 A	12 kW	20 A	440-480V, 3 PH, NA ETL	50-60 Hz
800614	26 A	12 kW	30 A	440-480V, 2 PH, NA ETL	50-60 Hz

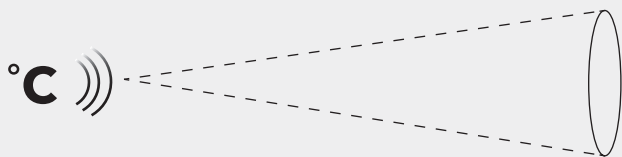

PCAUTO:

Place 60 cm from curing surface.
Laser circle sample area is Ø 30 cm (pyrometer ratio 1:2).
The pyrometer determines an average temperature reading in this area.

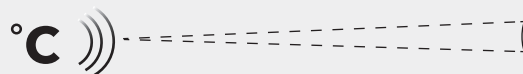

DTP:

Place 40-60 cm from curing surface.
Laser circle sample area is Ø 3-4 cm (pyrometer ratio 1:15).
The pyrometer determines an average temperature reading in this area.



IRT HIGH TEMPERATURE DRYERS

For spot repair and curing of paint material up to 200°C/390°F

- Automatic temperature control and distance measuring
- 15 process programs (customizable)
- Cures typical spot repair, A-B-C pillars and thicker steel materials



IRT 424 DTP 4-1



IRT 464 DTP 4-2



IRT 4 HI-BAKE

HiBake is a *MANUAL* alternative to the DTP model, with 50% flash-off, 100% fullbake.

IRT HIGH TEMP DRYERS

Cassette	Drying surface (LxH)	No. of cassettes	No. of lamps	Power
IRT 4 HI-BAKE	300x300 mm	1	3	3 kW
IRT 424 DTP 4-1	400x300 mm	1	2	4 kW
IRT 424 DTP 4-2	1000x300 mm	2	4	8 kW
IRT 425 DTP 4-1	500x300 mm	1	2	4 kW
IRT 425 DTP 4-2	1200x300 mm	2	4	8 kW
IRT 428 DTP 4-1	800x300 mm	1	2	6 kW
IRT 428 DTP 4-2	1800x300 mm	2	4	12 kW
IRT 464 DTP 4-1 (6 kW)	600x600 mm	1	6	6 kW
IRT 464 DTP 4-1 (10 kW)	600x600 mm	1	6	10 kW
IRT 464 DTP 4-2 (12 kW)	1200x600 mm	2	12	12 kW
IRT 464 DTP 4-2 (20 kW)	1200x600 mm	2	12	20 kW

Please contact your local retailer or IRT sales contact for assistance with a suitable IRT DTP dryer.



ULTRAVIOLET (UV-A) CURING

UV-A dryers with outstanding curing performance

All IRT UV-A models have an outstanding intensity to achieve the best curing result, even curing thick filler layers.

IRT UV-A high efficiency pressure lamp mobiles are equipped with one or two 1000 W UV-A lamps which cure UV-A material in just a few minutes. The ozone-free lamps and protective glass filters out the UV-B and UV-C radiation. A safety switch prevents the lamps from igniting if the glass breaks. Our UV-A LED models are extremely efficient, curing UV-A primer and filler in seconds.

- Outstanding intensity
- High-quality and durable curing
- Developed with market leading paint manufacturers

UV-A LED

Battery- and cord operated models available in 365 nm and 395 nm. High-intensity, flexible and precise UV-A LED curing for specific wavelengths.

MOBILE MODELS, HID LAMPS

Mobile, long-life, low maintenance, high efficiency UV-A curing with large curing area.

SAFE UV-A CURING

Third party UV safety report (EN62471) for operator safety. UV-LED modules and low pressure bulbs are installed safely behind protective glass. Ozone-free low pressure bulb lamp design.

SAFETY FIRST

Always use UV safety glasses when handling UV-A light. We supply a pair with each delivered unit.



IRT UVA 1-3

Curing with high efficiency UV-A lamps

- Curing on vertical surfaces
- One UV-A lamp with protective glass
- Curing time is regulated with an electronic timer

IRT UVA 1 PREPCURE 3

Part no.	Power	Fuse	Voltage	Frequency
800604	1 kW UV-A	10 A	230V, 1 PH, EU	50-60 Hz
800668	1 kW UV-A	10 A	230V, 1 PH, AUS & ARG type 1	50-60 Hz
800671	1 kW UV-A	15 A	230V, 1 PH, NA	50-60 Hz

DIMENSIONS

Stand height	1531 mm
Cassette vertical range (height)	60-1310 mm
Width	694 mm
Weight	60 kg
Curing area*	1,0 x 1,0 m

* At a distance of 55 cm



IRT UVA 1-4

High-quality, durable UV-A curing

- Flexible stand enabling curing of roofs on vehicles
- One UV-A lamp with protective glass
- Curing time is regulated with an electronic timer

DIMENSIONS

Stand height	1448 mm
Cassette vertical range (height)	35-2200 mm
Width	1224 mm
Weight	65 kg
Curing area*	1,0 x 1,0 m

* At a distance of 55 cm



IRT UVA 1 PREPCURE 4

Part no.	Power	Fuse	Voltage	Frequency
800621	1 kW UV-A	10 A	230V, 1 PH, EU	50-60 Hz
800669	1 kW UV-A	10 A	230V, 1 PH, AUS & ARG type 1	50-60 Hz
800672	1 kW UV-A	15 A	230V, 1 PH, NA	50-60 Hz

IRT UVA 2-4

Large curing area with two UV-A lamps

- Flexible stand enabling curing of roofs on vehicles
- Two UV-A lamps with protective glass
- Curing time is regulated with an electronic timer

IRT UVA 2 PREPCURE 4

Part no.	Power	Fuse	Voltage	Frequency
800622	2 kW UV-A	10 A	230V, 1 PH, EU	50-60 Hz

DIMENSIONS

Stand height	1448 mm
Cassette vertical range (height)	35-2200 mm
Width	1224 mm
Weight	81 kg
Curing area*	1,8 x 1,0 m

* At a distance of 55 cm

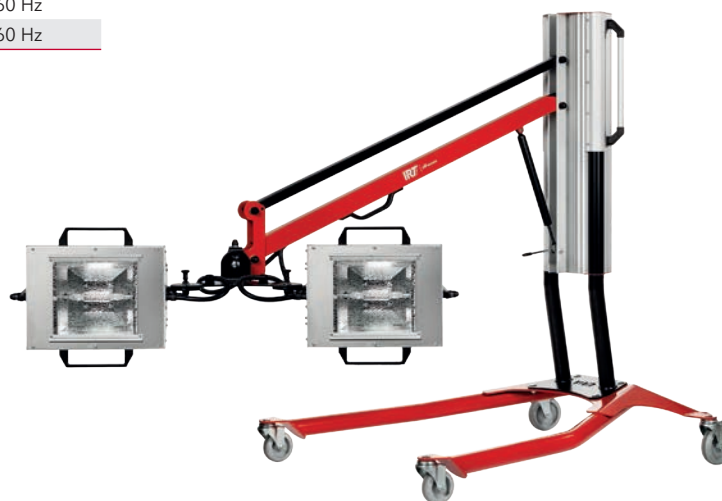



IRT UV-A LED CURING

WHY UV-A LED CURING?

UV-A curing with Light-Emitting Diodes (LED) generates, near-instant curing intensity, cold curing the painted surface without heating up the surrounding air.

Overall maintenance is reduced and the elimination of a warm-up cycle reduces technician down time.

WHAT IS A PHOTO INITIATOR (PI)*?

The energy in the UV-A light polymerizes and cures the UV-A material. The chemical reaction is triggered by a photo initiator and the speed of the process is determined by the energy or intensity of the UV-A light source and the wavelength.

WHY THIRD PARTY INSPECTION?

Third party testing confirms that a product exceeds quality, safety, sustainability and performance of applicable standards for a global product.

Two independent 3rd party inspectors (RISE and Intertek) review our products and our user instructions.

BENIFITS OF INDUSTRY COOPERATION?

By working closely with major paint manufacturers, crucial user experience and expectancy are added to our product development.

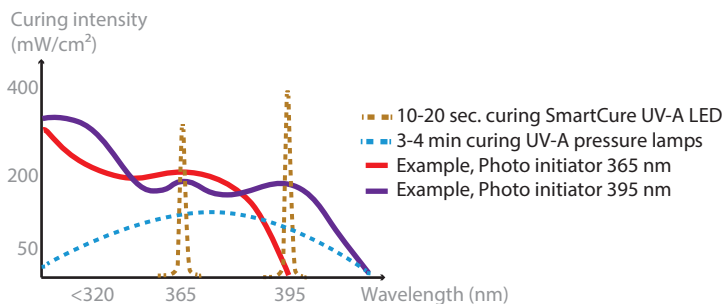

*Illustrating the correlation between PI wavelength, curing speed and UV-A light intensity.



SmartCure is available in wavelength alternatives 365/395 nm, based on paint manufacturer requests. It is prepared for future adaptations and can be retrofitted from 395 nm to 365 nm.

100% CURED

Non-fluctuating curing cycle

The key to high quality, reliable results is in maintaining a non-fluctuating intensity through the complete curing cycle.

Therefore, measuring and comparing light intensity is tricky, showing only a moment of truth. Once the primer/filler surface is sealed, you need to rely on the inside being cured.

With IRT, a combination of curing know-how, high-end parts, sophisticated software and inhouse/third party/user tests will cure your material 100%, every time.

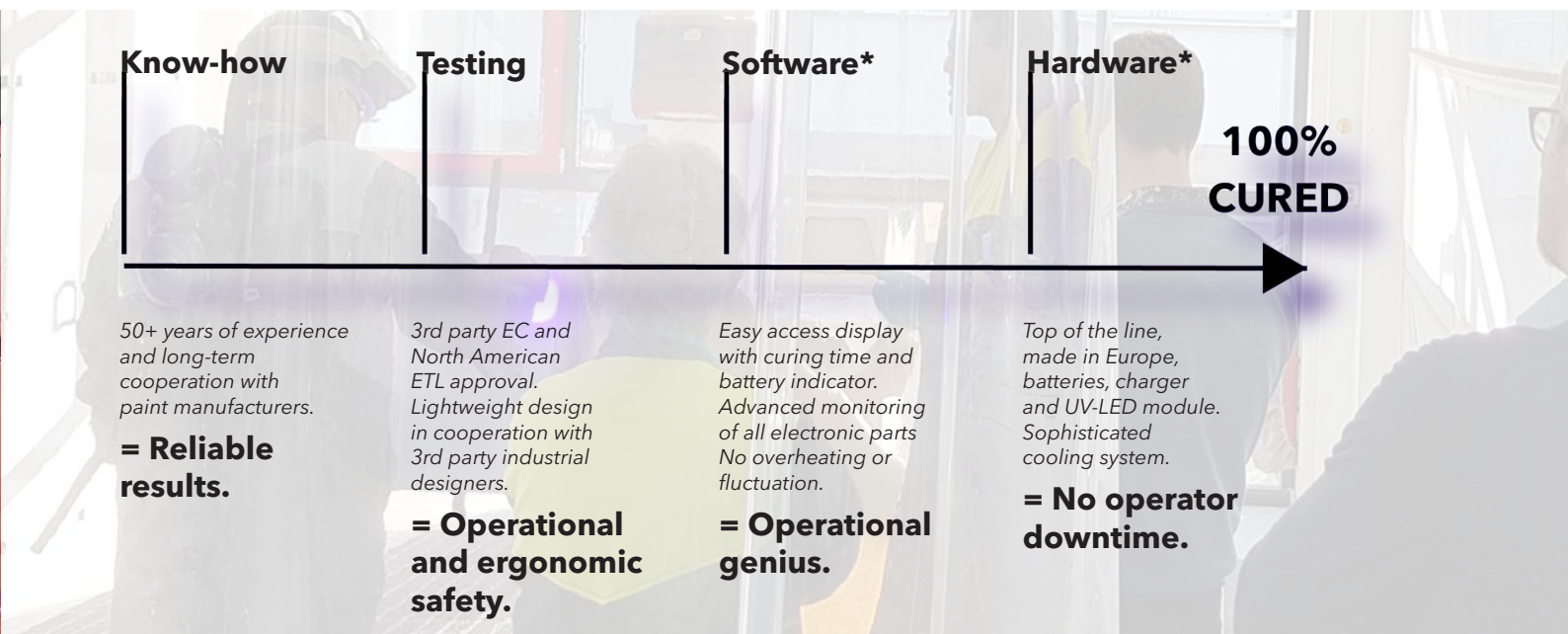

*Example, SmartCure

IRT TESTING

We have tested UV-A fillers, primers and clear coats from every major paint manufacturer and offer solutions for all.

Flexible handheld/fixed cord solutions for the static work place. Battery operated lightweight handheld options for accessibility that eliminates downtime in the work shop.

Our UV-A LED options are available for 365 nm and 395 nm.

IRT UV-A

We have long experience in a leading position on the international curing and drying market.

Our UV-A range of products for body shops and manufacturing industries comes in all shapes, super light handheld tools and easy positioned heavy duty mobiles.

Also checkout IRT's range of UV-A pressure lamps combined with IRT infrared technique, available as mobiles and rail systems for a wider UV-A spectrum.



SUPER LIGHT AND ERGONOMIC

- Tested to withstand high impact.
- Flame resistant plastic shell reinforced with 25% glass fiber and 3 mm scratch and solvent resistant tempered safety glass.
- Lightweight comfort and easy to use with a precise trigger switch.



WITH 2
BATTERIES

IRT UV SMARTCURE

200 W UV-A LED battery powered curing

SmartCure comes with two exchangeable batteries and cures UV-A filler and primer in seconds, available for 365 nm/ 395 nm.

IRT UV SmartCure has an extremely powerful output, offering market leading peak/average light intensity.

By combining a powerful UV-LED-module, advanced cooling technology and light weight batteries, reliable, highly effective, non-fluctuating UV-curing is achieved.

Advanced electronics minimizes the risk of machine damage by active ventilation and by monitoring the temperature of both electronics and LED-module. This provides safe operation with efficient steady state voltage LED-output and current control regulation.

- Available for 365 nm/ 395 nm
- Weighs just 1 kg, for excellent work comfort
- High intensity is constant until battery is at 0%

ELIMINATE DOWNTIME

With two exchangeable 18V lithium-ion batteries and 45 minute charging time, IRT UV SmartCure is always available.

RELIABLE CURING RESULTS

By working closely with leading paint manufacturers IRT enables reliable paint processes in all bodyshops.

ULTIMATE CURING GUIDE

To obtain peak performance, work at appr 100 mm from surface. @ filler/primer thickness 80-120 μm , \varnothing 160 mm is cured in appr 10 sec. (Peak light intensity $>350 \text{ mW/cm}^2$, average $>250 \text{ mW/m}^2$).



DUST COVER

Optional protective dust cover with magnets, art no 715193.

WALL BRACKET

Magnetic wall bracket, included as standard.



UNIQUE BEAM SPREAD

24 pieces of domed LED's create a unique beam spread over the complete curing area.



HARD CASE* / CARDBOARD BOX*

Optional heavy-duty case, art no 800806.

LOW MAINTENANCE

Replaceable filter protects electronics inside, art nr 715074.



DISPLAY GUIDES THE WAY

All fillers, primers and clear coats have different curing cycles.



DETAILS

Battery type	18 V Lithium-ion
Weight, IRT UV SmartCure + 1 battery	1,16 kg
Dimensions, IRT UV SmartCure + 1 battery (WxHxD)	189x250x88 mm

IRT UV SMARTCURE

Part no.	Article	Current, SmartCure / Charger	Power	Voltage (Battery charger)	Risk Group EN 62471	Frequency
715070-X*	SmartCure 395 nm	8A/2A	200 W	100-240 V	(RG-3)	50-60 Hz
715365-X*	SmartCure 365 nm	8A/2A	200 W	100-240 V	(RG-3)	50-60 Hz

2 batteries, charger, magnetic wall bracket and UV Safety glasses included in delivery. Ambient temp max 40° C.

* SmartCure 395 nm alternatives:
 EU; in cardboard box 715070-1 / EU; in hard case 715070-2
 NA; in cardboard box 715070-3 / NA; in hard case 715070-4
 UK; in cardboard box 715070-5 / UK; in hard case 715070-6
 JP; in cardboard box 715070-7 / JP; in hard case 715070-8
 AUS; in cardboard box 715070-9 / AUS; in hard case 715070-10

* SmartCure 365 nm alternatives:
 EU; in cardboard box 715365-1 / EU; in hard case 715365-2
 NA; in cardboard box 715365-3 / NA; in hard case 715365-4
 UK; in cardboard box 715365-5 / UK; in hard case 715365-6
 JP; in cardboard box 715365-7 / JP; in hard case 715365-8
 AUS; in cardboard box 715365-9 / AUS; in hard case 715365-10



IRT UV SMARTCURE

- 1** Specially developed UVA-LED, optimized to fully and securely cure 395 nm coatings.
- 2** Superior LED-module, completely customized for IRT UV SmartCure. Completely sealed to avoid dust and dirt that could decrease light performance.
- 3** Safety glass, 3 mm scratch and solvent resistant tempered glass with glass fiber reinforced frame to prevent glass from breaking. Protects the UV-LED's.
- 4** Skived fin heat sink to get best possible heat management.
- 5** Ergonomic grip with precise trigger switch.
- 6** High performance 18V Lithium-ion rechargeable battery.
- 7** Display with timer, battery level and other useful functions.
- 8** Powerful fan to get maximum cooling.
- 9** Advanced electronics with amplifier and inductor for high-efficiency DC/DC converters which makes it possible to get a higher curing effect.
- 10** Flame resistant plastic shell reinforced with 25 % glass fiber to withstand high impact.
- 11** Temperature sensors to guarantee that neither the electronics or LED's can be overheated.

NEXT GENERATION UV LAMPS FROM IRT

IRT UV SPOTCURE²

3 times stronger on spot and panel repairs

POWERFUL DETAIL

- 132 high-power LED
- Individual optics on each LED
- Temperature regulated ventilation
- Reliable curing results, built to last

POWER-UP

- More light intensity over a larger surface
- Cures Ø 30 cm (12") in 20 seconds
- Cures Ø 70 cm (27.5") in a minute
- Cures Ø 100 cm (39.4") in 2 minutes

BETTER FOR YOU

- Multifunction timer display
- Press and go, saves your last settings
- Ergonomic grip
- Light-weight stand (optional)

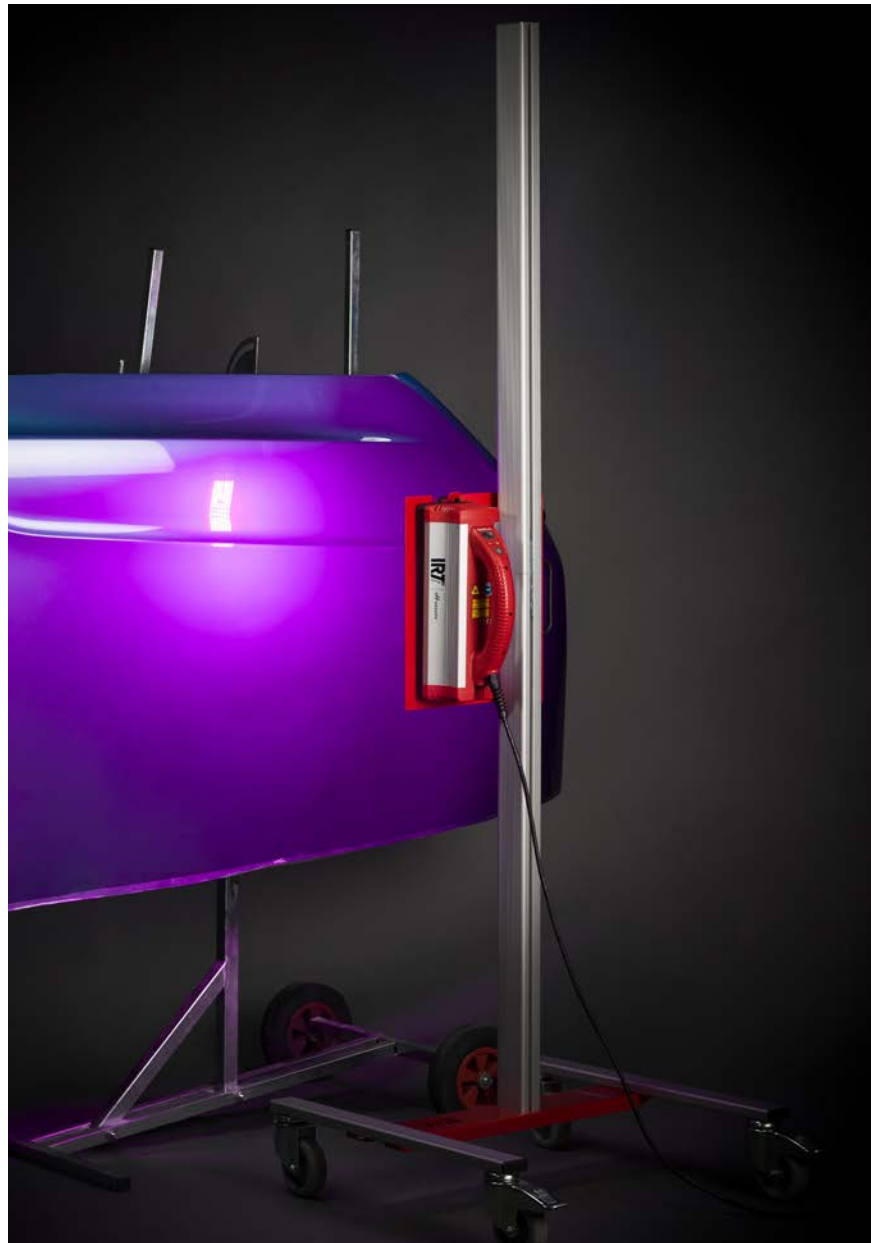

3 TIMES MORE POWERFUL*

Our bestselling UVLED range expands with power-packed SpotCure².

An unbeatable combination of power and curing size.

Taking operational safety and user comfort to a new level.

*SpotCure¹ light effect 50 W, SpotCure² light effect 150 W.



NEXT GENERATION UV LAMPS FROM IRT

IRT UV SPOTCURE²

More light intensity over a larger area



POWERPACKED SPOTCURE²

Curing areas like never before, with the same reliable curing result. Perfectly balanced hand comfort for spot repair or panel repairs (with optional stand).

Powerful, temperature regulated ventilation - built to last

Uniform light intensity

Advanced overheating protection

User comfort with grip ribs and membrane display

DIY exchangeable power cord

Filter replacement indicator

User preference memory function

Operational safety with third party certification

Multi-function timer display guides the way

Ergonomic design - for a healthier work environment

NEXT GENERATION UV LAMPS FROM IRT

IRT UV SPOTCURE²

Hand- and stand operation



Comfortable with ergonomic design and grip ribs.
Press and go, saves your last settings.

TECHNICAL DATA IRT UV SPOTCURE ²	
Voltage	100- 240 V
Power	300-400 W
LED unit	132 pcs high power, individual optics
Weight, SpotCure ²	2 kg (4 lbs)
Weight, Stand for SpotCure ²	11.5 kg (25 lbs)
Dimensions, SpotCure ²	335 x 116 x 172 mm (13" x 4.5" x 7")
Dimensions, Stand for SpotCure ²	622 x 605 x 1940 mm (24.5" x 24" x 76")
LED Wavelength	395 nm UV-A
Risk Group EN 62473	3
PART NO.:	
IRT UV SpotCure ²	EU: 800900 / UK: 800901 / NA: 800902
Stand for IRT UV SpotCure ²	800907
Hard case for SpotCure ²	800906
5 pcs inlet filter+5 pcs outlet filter	715425
Power cord, 1.8 m	EU: 715429 / UK: 715430 / NA: 715431
UV safety glasses	129070*

*1 pair included in delivery



NEXT GENERATION UV LAMPS FROM IRT

IRT UV SPOTCURE²

CURING FACTS SPOTCURE²

132 high power LEDs, each with unique optics. Designed to create high and uniform LED light intensity over a large area.

Combined with powerful, temperature regulated ventilation and advanced overheating protection, SpotCure² offers market leading curing results from IRT, the curing company.

Product lifetime, operational safety and ergonomics are always top priority.



132 high power LEDs, each with unique optics.

10 CM (4") DISTANCE	
Curing area	Ø 30 cm (12")
Light intensity average/peak	90/120 mW/cm ²
Curing time	10-20 sec*
30 CM (12") DISTANCE	
Curing area	Ø 70 cm (27.5")
Light intensity average/peak	14/19 mW/cm ²
Curing time	1 minute*
40 CM (18") DISTANCE	
Curing area	>Ø 100 cm (39.5")
Light intensity average/peak	<8 mW/cm ²
Curing time	<2 minutes*

*Average curing times for a selection of UV Fillers available on the market. Details for specific UV activated materials are individual and can vary.

- Closer to object >> Smaller curing area >> Higher intensity >> Shorter curing time
- Further from object >> Larger curing area >> Lower intensity >> Longer curing time



COMBINATION OF IR AND UV-A CURING

Our best in class IR and UV-A dryers in one

The IRT COMBI dryer is 2 in 1 - saving space in the workshop while allowing complete flexibility.

The combination of short-wave infrared and UV-A radiation makes this mobile dryer unique. One cassette includes 4 IR lamps and 1 UV-A lamp.

The UV-A lamps have an outstanding intensity to achieve the best curing result. The infrared lamps are mounted in gold coated reflectors, reflecting up to 97 % of the short-wave radiation.

The IRT COMBI features 12 IR and 3 UV-A pre-programmed programs for water and solvent based paint material, from putty to clear coat. Available as flexible mobiles and easy-gliding rail dryers.

- High-quality and durable curing
- Space saving curing solution
- Short-wave IR drying and UV-A curing

SAFE UV-A CURING

The ozone-free lamps and the protective glass filters out the UV-B and UV-C rays. If the glass breaks or is missing, the light has a safety switch preventing the lamp to ignite.

FLEXIBILITY AND EFFICIENCY

Space saving infrared and UV-A drying techniques which can be run individually and in sequence.

SAFETY FIRST

Always use UV safety glasses when handling UV-A light. We supply a pair with each delivered unit.



IRT 4-1 IR-UVA

Mobile dryer with unique combination of IR and UV-A techniques

- One cassette with 4 IR lamps and 1 UV-A lamp
- Featured with 12 IR- and 3 UV-A pre-programmed programs
- Easy to position

DIMENSIONS

Stand height	1450 mm
Cassette vertical range (height)	80-2240 mm
Width	1230 mm
Weight	70 kg
Curing area	
- IR*	1,1 x 1,5 m
- UV-A**	1,0 x 1,0 m

* Curing area at a distance of 60 cm, on black sheet metal
 ** At a distance of 55 cm



IRT COMBI 4-1 IR-UVA

Part no.	Power	Fuse	Current	Voltage	Frequency
800605	IR: 6 kW UVA: 1,2 kW	10 A	IR: 9 A UVA: 3 A	380-420V, 3 Ph/PE	50-60 Hz

IRT 4-2 IR-UVA

Mobile dryer with unique combination of IR and UV-A techniques

- Two cassettes, each cassette equipped with 4 IR lamps and 1 UV-A lamp
- Featured with 12 IR- and 3 UV-A pre-programmed programs
- Easy to position

DIMENSIONS

Stand height	1450 mm
Cassette vertical range (height)	80-2240 mm
Width	1230 mm
Weight	85 kg
Curing area	
- IR*	2,2 x 1,5 m
- UV-A**	1,8 x 1,0 m

* Curing area at a distance of 60 cm, on black sheet metal
 ** At a distance of 55 cm



IRT COMBI 4-2 IR-UVA

Part no.	Power	Fuse	Current	Voltage	Frequency
800606	IR: 12 kW UVA: 2,4 kW	16 A	IR: 16 A UVA: 6 A	380-420V, 3 Ph/PE	50-60 Hz



IRT 4-10 IR-UVA

Rail dryer with IR and UV-A radiation

- One cassette with 4 IR lamps and 1 UV-A lamp
- 12 IR- and 3 UV-A pre-programmed programs
- Unique combination of IR and UV-A curing



IRT COMBI 4-10 IR-UVA

Part no.	Power	Fuse	Current	Voltage	Frequency
800618	IR: 6 kW UVA: 1,2 kW	Max 100 A	IR: 9 A UVA: 3 A	380-420V, 3 Ph/PE	50-60 Hz

DIMENSIONS

Installation height	2250-3150 mm
Cassette vertical range (height)	80-2240 mm
Weight	70 kg
Curing area	
- IR*	1,1 x 1,5 m
- UV-A**	1,0 x 1,0 m

* Curing area at a distance of 60 cm, on black sheet metal
** At a distance of 55 cm

IRT 4-20 IR-UVA

Rail dryer with IR and UV-A radiation

- Two cassettes, each cassette equipped with 4 IR lamps and 1 UV-A lamp
- 12 IR- and 3 UV-A pre-programmed programs
- Unique combination of IR and UV-A curing



IRT COMBI 4-20 IR-UVA

Part no.	Power	Fuse	Current	Voltage	Frequency
800619	IR: 12 kW UVA: 2,4 kW	Max 100 A	IR: 16 A UVA: 6 A	380-420V, 3 Ph/PE	50-60 Hz

DIMENSIONS

Installation height	2250-3150 mm
Cassette vertical range (height)	80-2240 mm
Weight	85 kg
Curing area	
- IR*	2,2 x 1,5 m
- UV-A**	1,8 x 1,0 m

* Curing area at a distance of 60 cm, on black sheet metal
** At a distance of 55 cm



WORKSHOP CUSTOMIZATION

Please contact your local retailer or IRT sales contact for assistance with customization for your workshop.

IRT RAIL SYSTEMS

Tailor-made for prep area and spray booth

Operational safety with integrated cables

The IRT Rail System can be equipped with any number of IRT dryers, all hanging on easy-glide, self-balanced cassette arms.

With the IRT Rail System you can quickly maneuver the dryer into the perfect curing position, reaching all parts of the vehicle, without obstructing loose cables. The IRT Rail System comes in a variety of shapes and sizes and is customizable to suit any type of workshop.

OPERATIONAL SAFETY

High quality with closed rails and integrated cable system extends lifetime and creates a maintenance free environment.

LOWBUILT TO SUIT WORKSHOPS

Long experience with rail system installation has resulted in this extremely lowbuilt construction.

FOR PREP AREA & SPRAY BOOTH

Our standard sidehung cross rail system fits most workshops. Customized solutions are also available to fit all prep areas and paint booths.



SIDEHUNG CROSS RAIL SYSTEM Standard.
(Max length cross rail 7 m (22'11"))

UNDERHUNG CROSS RAIL SYSTEM



WALL RAIL SYSTEM



RAIL SYSTEM



IRT RAIL DRYERS

Easy gliding and self-balancing dryers



SAFE AND CLEAN

As the electric power supply is integrated in the rails, there are no loose cables dragging along the floor disrupting work and stirring up dust.



IRT CONTROL SYSTEM

User-friendly advanced system, pre-programmed to monitor the curing process.



DUST & SURVEILLANCE SYSTEM

Optional, use in enclosed spray booth or combined spray and dry booth. Security control of unit and protection of the cassettes.



IRT 3-20

Adapted for prep station and spray booth

- Two cassettes - each cassette with 3 IR lamps
- Electronic distance sensor
- Computerized curing process



IRT 3-20 PCD

Part no.	Current	Output power	Fuse	Voltage	Frequency
800477	15 A	6 kW	16 A	200-230V, 3 PH, EU, JP	50-60 Hz
800463	9 A	6 kW	16 A	400V, 3 PH, EU	50-60 Hz

DIMENSIONS

Installation height	2250-3150 mm
Cassette vertical range (height)	140-2500 mm
Weight	60 kg
Curing area*	2,0 x 1,1 m

* Curing area at a distance of 60 cm, on black sheet metal



IRT 4-10

User friendly advanced technology

- One cassette with 4 IR lamps
- Controls the temperature with a pyrometer and laser circle
- Computerized monitoring of curing
- Electronic distance sensor



IRT 4-10 PCAUTO

Part no.	Current	Output power	Fuse	Voltage	Frequency
800489	9 A	6 kW	10 A	400V, 3 PH, EU	50-60 Hz
800525	15 A	6 kW	20 A	200-230V, 3 PH, NA ETL	50-60 Hz
800494	9 A	6 kW	15 A	440-480V, 3 PH, NA ETL	50-60 Hz

DIMENSIONS

Installation height	2250-3150 mm
Cassette vertical range (height)	140-2500 mm
Weight	50 kg
Curing area*	1,1 x 1,5 m

*)Curing area at a distance of 60 cm, on black sheet metal

IRT 4-20

User friendly advanced technology

- Two cassettes with 4 IR lamps
- Controls the temperature with a pyrometer and laser circle
- Computerized monitoring of curing
- Electronic distance sensor



IRT 4-20 PCAUTO

Part no.	Current	Output power	Fuse	Voltage	Frequency
800480	30 A	12 kW	32 A	200-230V, 3 PH, EU, JP	50-60 Hz
800498	30 A	12 kW	30 A	200-230V, 3 PH, NA ETL	50-60 Hz
800464	17 A	12 kW	20 A	400V, 3 PH, EU	50-60 Hz
800479	17 A	12 kW	20 A	440-480V, 3 PH, NA ETL	50-60 Hz

DIMENSIONS

Installation height	2250-3150 mm
Cassette vertical range (height)	140-2500 mm
Weight	60 kg
Curing area*	2,2 x 1,5 m

*)Curing area at a distance of 60 cm, on black sheet metal

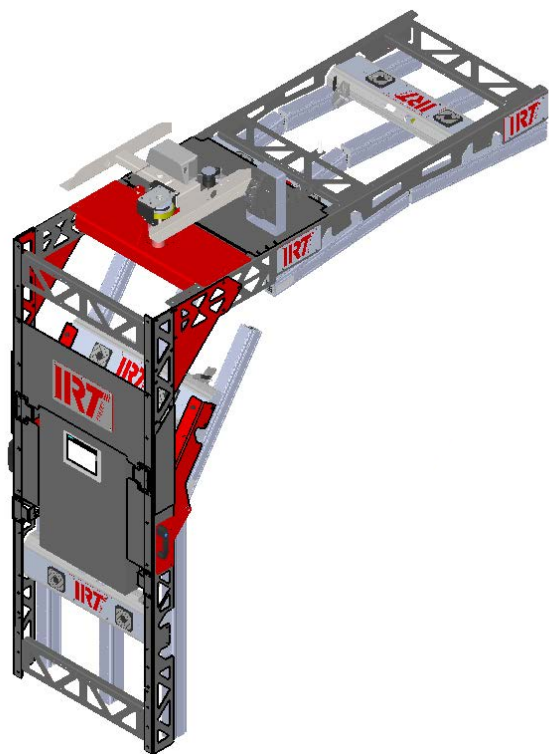

IRT FLEXICURE

Shorter curing times in the prep area

IRT FlexiCure moves over the chosen panel automatically, curing from the inside out, preventing solvent to be trapped inside the coating, ensuring fast and high quality curing.

Accelerated curing in the prep area, both automatic and manual, static and dynamic. Simply choose the desired panels to be dried and start the curing process thereby contributing to a cost-effective and environmental friendly process.

- Flexible installation in prep area with IRT Rails
- Tiltable zone for adjusted effect
- Requires very little parking space

TIME SAVING IN THE PREP AREA

IRT FlexiCure is installed in a standard IRT Rail System and accelerates curing of water- and solventbased base and clear coats.

4 CURING ZONES

Each zone is equipped with shortwave infrared lamps, gold coated reflectors and pyrometer. 3 IR lamps/zone with a total power of 38 kW.

COST EFFECTIVE PROCESS

IRT FlexiCure saves energy by only activating the necessary IR lamps using pyrometers and distance sensors.

WORKSHOP CUSTOMIZATION

Please contact your local retailer or IRT sales contact for assistance with customization for your workshop.

TECHNICAL DATA

Rated voltage	Nominal frequency	Full load current	Main disconnect fuse	Sound pressure level	Sound power level	Curing temp. (curing surface)	Ambient temp. (during operation)	Weight FlexiCure excluding rails
400-480 V ~3Ph/PE ± 5%	50-60 Hz	55 A	65 A	≤ 70 dB (A) at 1 m	≤ 70 dB (A) at 1 m	Max. 170°C	Max. 40°C	150 kg



IRT POWERCURE

Shorter curing times in the spray booth

IRT PowerCure drastically shortens curing times for all paint materials with a minimum of energy used.

IRT PowerCure turns your traditional booth into a rapid curing booth. The vehicle is ready to move forward in minutes. Selection of panels and paint type is done quickly and easily on the touch control panel. The vehicle and loose parts can be cured in the same drying cycle.

IRT PowerCure can be installed in new spray booths as well as be retrofitted in existing spray booths. Calculate 1,2 m for IRT PowerCure and another minimum 8 meters to pass over the vehicle and angle front/back.

- Easy to retrofit in spray booth (min 9,2 m)
- Reaches front/back of vehicle with angling wings
- Adapts to paint material, size and shape of vehicle
- A typical coating is cured in 10 minutes or less

WORKSHOP CUSTOMIZATION

Please contact your local retailer or IRT sales contact for assistance with customization for your workshop.

TECHNICAL DATA

Frequency	Installed Power	Voltage	Part no.
50-60 Hz	54 kW / 63 A (20 lamps à 3 kW less 6 kW supply voltage compensation)	400 V, 3Ph ~/PE	800410* IRT PowerCure Single 800490* IRT PowerCure Double

*) Incl. Surveillance System

EVEN HEAT DISTRIBUTION

The front and back of the vehicle are easily cured with the wing angled towards the painted surface. The shape and positioning of the reflectors give an even heat distribution.

LESS ENERGY CONSUMPTION

IRT PowerCure detects the starting position and saves energy by only activating the necessary IR lamps. Simply choose the desired panels to be dried and start the curing process.

ENERGY CONSUMPTION

Typical energy consumption, clear coat on base coat, medium sized vehicle, medium colour shade:

Front wing	6 min	0,95 kWh
Door	5 min	0,95 kWh
Front wing + door	10 min	1,6 kWh
Hood	7 min	1,5 kWh
Hood + 2 wings	9 min	2,8 kWh
Complete car	26 min	15,8 kWh

ENERGY SAVING, ROBOTIC CURING FROM IRT

IRT ICURE

Robotic, all inclusive dryer for booth and prep zone

COMPACT ROBOTIC RAIL DRYER

- Retrofits to spray booths and prep zones with minor adjustments

IR AND UV CURING

- Save time - ready to handle in minutes
- Reliable, precise curing results

BETTER FOR THE ENVIRONMENT

- Low energy spend per vehicle
- No energy waste in between jobs

BETTER FOR YOU

- Always comfortable booth temperature
- Pre-programmed - easy to operate
- Park in a corner, out of your way

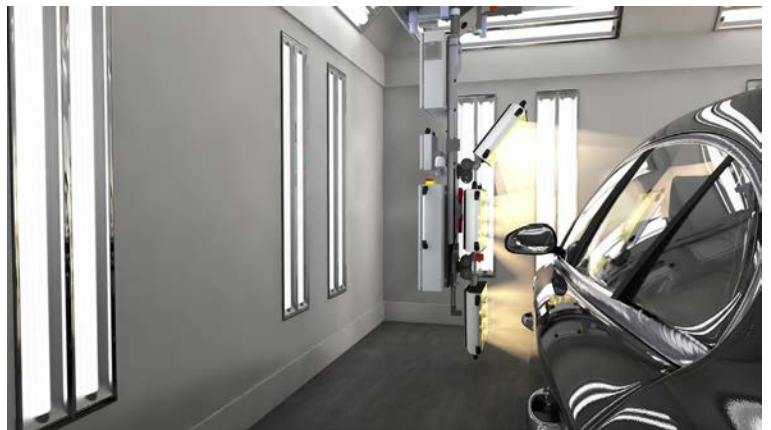

ROBOTIC TRAVEL



AUTOMATED CURING

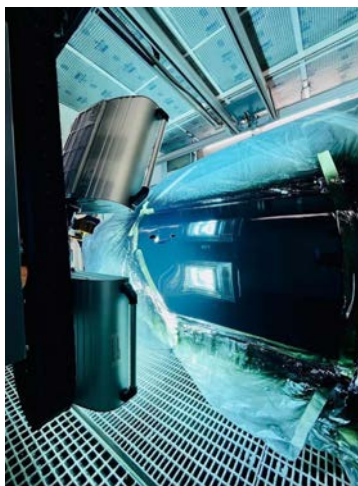

ULTRAVIOLET (UV) CURING



INFRARED (IR) CURING



ENERGY SAVING, ROBOTIC CURING FROM IRT

IRT ICURE

Robotic, all inclusive dryer for booth and prep zone

DYNAMIC AND STATIC CURING

- All you need in one unit
- IR and UV curing
- Preprogrammed recipes for both

TWICE AS POWERFUL

- New HID UV lamps
- 2000 W UV lamp in each cassette
- Cures all UV-activated materials on the market

IRT INFRARED

- Original IRT infrared
- Proven cassette concept

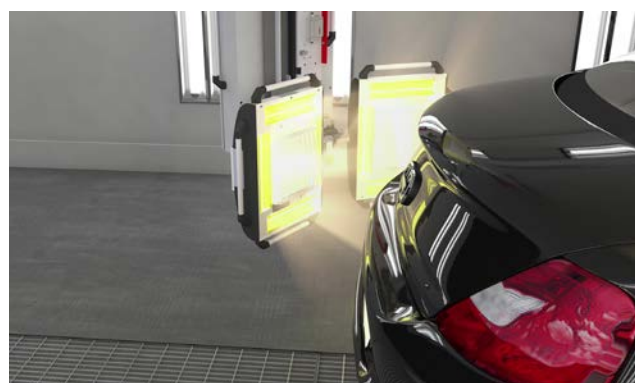

FLEXIBLE CASSETTE ADJUSTMENT

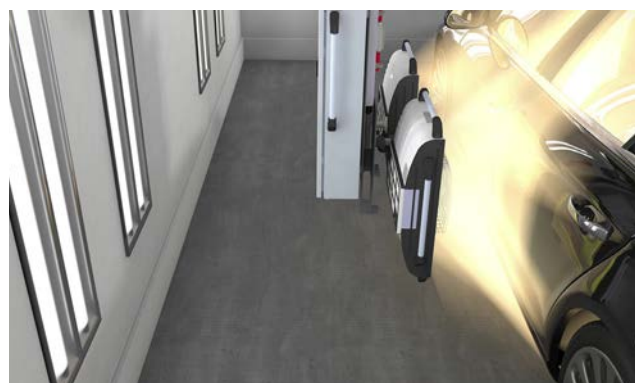

STATIC OPTION

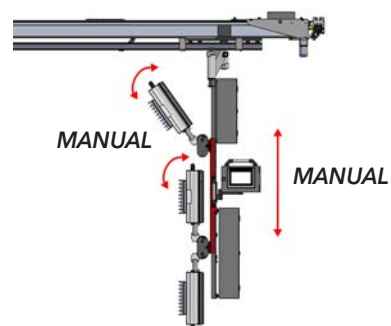
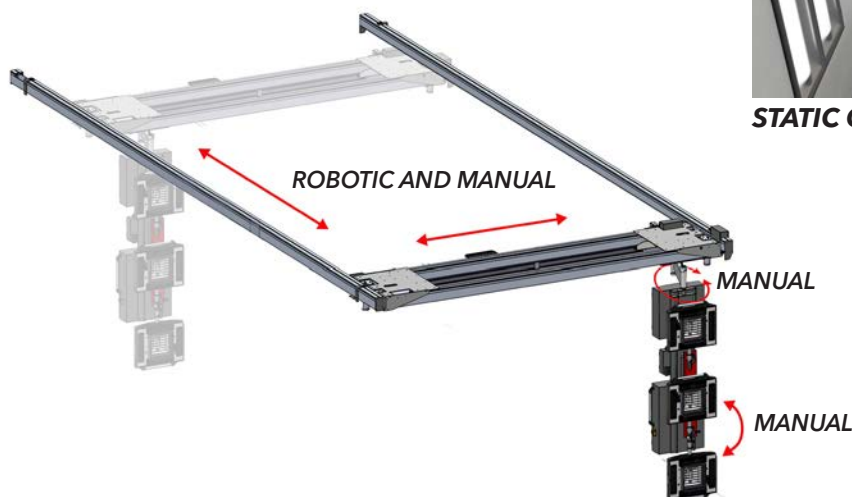

ROBOTIC:

Robotic motion and automated curing on long side or short side

MANUAL:

Rotate and move ICure in the rail system

Rotate cassette position of the two bottom cassettes, 0-90°

Adjust ICure position up/down 0-480 mm

ENERGY SAVING, AUTOMATED DRYING FROM IRT

IRT ICURE

All inclusive booth and prep zone dryer



Robotic motion along the long / short side of the vehicle

Flexible and easy to move into all positions manually

Both dynamic and static drying available

2000 W HID UV-A lamps

Guarded UV safety glass, ozon-free

Plug and Play, preprogrammed and DIY recipes

IR lamps > 20.000 hrs, life time counter for UV lamps

IRT shortwave infrared, >97% effective

Gold coated reflectors determin high efficiency

Time saving and exact drying process

IRT ICURE

Art.nr	Nominal frequency	Rated Voltage	Full load currenxy	Main disconnect fuse	Sound pressure / power level	Ambient temp. (during operation)
ICure 737413	50-60 Hz	400-480 V~3Ph/ PE ± 5%	26 A	32 A	≤ 70 dB (A) at 1 m	Max. 40°C



**It's not an arch,
not a half-arch.
It is a new, compact
I-shaped robotic COMBI dryer.
IR and UV curing."*

THE IRT ICURE



IRT IR DRYERS

Basic features

	IRT 1 Prep- Cure	IRT 2 Prep- Cure	IRT 3 Prep- Cure	IRT 4 Prep- Cure	IRT 3-1 PcD	IRT 3-2 PcD	IRT 4-1 PcAuto	IRT 4-2 PcAuto
Even heat distribution	•	•	•	•	•	•	•	•
Short curing times	•	•	•	•	•	•	•	•
Environmentally friendly, efficient use of energy	•	•	•	•	•	•	•	•
24 carat gold coated reflectors with 97% reflection	•	•	•	•	•	•	•	•
Powerful ventilation provides the lamps with a service life of up to 20,000 operating hours	•	•	•	•	•	•	•	•
FreeForm reflectors for an unsurpassed drying surface	•	•	•	•	•	•	•	•
Efficient particle filter that creates a dust-free environment in the cassettes	•	•	•	•	•	•	•	•
Enclosed cassette cables	•	•	•	•	•	•	•	•
The angle of the arm provides increased reach	•	•	•	•	•	•	•	•
The stand is adapted also to dry high cars, e.g. SUVs	•	•	•	•	•	•	•	•
The arm is self-locking in all positions	•	•	•	•	•	•	•	•
Electronic distance sensor	•	•	•	•	•	•	•	•
Self-instructive programs	•	•	•	•	•	•	•	•
Computerized curing process	•	•	•	•	•	•	•	•
12 program pre-sets - 3 custom programs	•	•	•	•	•	•	•	•
Programs for plastic/metal/water/solvent	•	•	•	•	•	•	•	•
18 languages	•	•	•	•	•	•	•	•
Pyrometer for exact temperature control	•	•	•	•	•	•	•	•
Clear display with graphics showing the exact progress of the curing process	•	•	•	•	•	•	•	•
Computerized temperature monitoring of curing process	•	•	•	•	•	•	•	•
Laser circle indicates where temperature measurement takes place	•	•	•	•	•	•	•	•

IRT UV-A DRYERS

Basic features

	UVA 1-3	UVA 1-4	UVA 2-4	IR/ UVA 4-1	IR/ UVA 4-2	SpotCure ²	SmartCure
Environmentally friendly, efficient use of energy	•	•	•	•	•	•	•
Premium product with long lifetime >5 years	•	•	•	•	•	•	•
Powerful ventilation provides the lamps with a service life of up to 20,000 operating hours				• (IR)	• (IR)	•	•
Low maintenance	•	•	•	•	•	•	•
UV-LED						•	•
Handheld unit						+mobile	•
Battery operated							•
UV-A wavelength 395 nm						•	•
UV-A wavelength 365 nm						•	•
High efficiency UV-A pressure lamp	•	•	•	•	•		
UV-A wavelengths 315-395 nm	•	•	•	•	•		
IR: Cures water/solvent based products				•	•		
IR: Programs for plastic/metal/water/solvent				•	•		
IR: Computerized curing process				•	•		

SPARE PARTS

IRT UVA SpotCure²

	Art. no.
UV/IR Protective glasses	129070
Stand for IRT UV SpotCure ²	800907
Hard case for SpotCure ²	800906
5 pcs inlet filter+5 pcs outlet filter	715425
Power cord, 1.8 m	EU: 715429 UK: 715430 NA: 715431
Gable outlet	715427
Gable inlet	715426

IRT UVA SpotCure¹

	Art. no.
UV/IR Protective glasses	129070
Stand for SpotCure	800805
Timer for SpotCure stand (not for 800802, NA)	712821

IRT UVA SmartCure

	Art. no.
UV/IR Protective glasses	129070
Battery 18V Li-ion	715093
Battery charger 18V	715094
Filter	715074
Dust cover	715193
Hard case	800806
Cable for charger (EU plug)	715154
Wall bracket	715129

IRT COMBI IR-UVA

	Art. no.
UV/IR Protective glasses	129070
UV lamp replacement kit 400V 1,2 kW	714842
Lamp IR 2 kW 235V 360 U CPL	102699
Lamp IR 1 kW 235V 360 U CPL	102700
Filter cassette assembly w. nylon plugs	713576

IRT UVA X PrepCure X

	Art. no.
UV/IR Protective glasses	129070
Air filter	712894
UV lamp replacement kit 230V 1 kW	714599

IRT 1 & 2 PrepCure

	Art. no.
IR Lamp 360, 1kW, 230V	102700
Lamp holder LRU3 (M5x16) w. washer	712393
Knob (wing) male M8, for stand	410009
Timer EU 1 PH + PE, for stand	180508

IRT 3 & 4 PrepCure

	Art. no.
IR Lamp 360, 1kW, 230V	102700
Lamp holder LRU3 (M5x16) w. washer	712393
Fan 12V DC 92x92 mm	711186
Filter cassette assembly w. nylon plugs	713576
Gas spring 800 N - IRT4 PrepCure	713776
Main switch	420771
Keyboard PrepCure	750496
PCB (Printed Circuit Board) PrepCure	750481
Wheel kit, h=100mm, w=32mm	412364
Solid state relay cpl	126313
Adj bolt with with Nut M12*1,5	120295

IRT 3-X PcD

	Art. no.
IR Lamp 360, 1kW, 230V	102700
Lamp holder LRU3 (M5x16) w. washer	712393
Fan Hyperion 12V, w. mesh and plug	714011
Filter cassette assembly w. nylon plugs	713576
Gas spring 850 N - PcD (one cassette)	714060
Gas spring 1400 N (two cassettes)	713614
Solid state relay	750227
Wheel kit, h=134mm, w=32mm	410523
Transformer 230/400/480VAC/12VDC	750630
Display 128x64 points w. lightning	750220
Overlay/keyboard IRT 8 keys	750366
Distance sensor kit 3-1, 3-10 PcD	713737
Distance sensor kit 3-2, 3-20 PcD	713957
PCB (Printed Circuit Board) IRT 3-1 PcD	714012
PCB (Printed Circuit Board) IRT 3-2 PcD	714013

IRT 4-X PcAuto

	Art. no.
IR Lamp 360, 1kW, 230V	102700
IR Lamp 360, 2kW, 230V	102699
Lamp holder LRU3 (M5x16) w. washer	712393
Fan Hyperion 12V, w. mesh and plug	714011
Filter cassette assembly w. nylon plugs	713576
Gas spring 850 N (one cassette)	711464
Gas spring 1400 N (two cassettes)	713614
Solid state relay	750227
Wheel kit, h=134mm, w=32mm	410523
Transformer 230/400/480VAC/12VDC	750630
Display 128x64 points w. lightning	750220
Overlay/keyboard IRT 8 keys	750366
Pyrometerkit 4-1 PcAuto	713637
Pyrometerkit 4-2 PcAuto	713864
PCB (Printed Circuit Board) IRT 4-1 PcAuto	714014
PCB (Printed Circuit Board) IRT 4-2 PcAuto	714015



DRESTER GUN CLEANERS - THE ORIGINAL

Outstanding cleaning performance since 1978.
Durable and sustainable solutions.

- Certified and patented products with superior quality
- Swedish inventions satisfying customer needs
- 3 years warranty on diaphragm pumps
- ATEX approved
- Sustainable and durable solutions
- Offering the best working environment
- Manual or Automatic operation

WATER-BORNE

These spray gun cleaners are suitable for water-borne cleaning and they all comply with all paint manufacturers systems regarding cleaning and waste handling.

SOLVENT BASED

These spray gun cleaners are suitable for solvent based cleaning and they all fit the environment in which a spray gun cleaner operates.

COMBINATION OF BOTH

These spray gun cleaners are suitable for both solvent-based and water borne cleaning



Manual



Automatic



Waterborne



Solvent



ANOTHER FIRST FROM DRESTER

DRESTER ACE

Pioneering solvent- and waterbased spraygun cleaning



Drester Ace Quattro Combo

NEW AND UNIQUE CAPTURE@SOURCE

- Ventilation that captures emissions close to the source
- User exposure and solvent loss are minimized

COMPACT AND ERGONOMIC

- Comfortable work position and clear visibility

EASY TO USE - EASY TO CLEAN

- All-stainless solvent washing compartments

QUICK AND RELIABLE

- Patented universal spraygun holder



DRESTER
Ace

WELCOME TO SUSTAINABLE ACE

A better use of solvent is good for the environment and the paint shop. Optimized to be more ergonomic and work even more efficiently, for quick and safe spraygun cleaning.



DRESTER PUMPS

Powerful diaphragm pumps for effective and reliable cleaning results.



DRESTER SPRAYGUN HOLDER

Clip-on/clip off action. The paint channel is opened and the spraygun is secured all at once. The air channel is protected by an air purge hose.



DRESTER PUMPS (ATEX CAT 1/ZONE 0, SOLVENT GROUPS IIA AND IIB)

Our pump, the powerhouse behind all our systems, is focused on efficiency. Unparalleled flow and pressure from our pumps ensure the best possible cleaning power. The new advanced design of the wash compartment nozzle system is only possible, thanks to the robust pump, resulting in more effective wash cycles. With a track record of success spanning over 30 years, almost 200.000 Drester pumps were supplied.

DRESTER PATENTED SPRAYGUN HOLDER

Our patented universal spraygun holder opens the paint channel and fixes the spraygun in seconds, with the air channel protected by an air purge hose. Always excellent cleaning results and fits all spraygun brands immediately.

DRESTER CAPTURE@SOURCE VENTILATION

Drester Capture@Source ventilation provides superior working conditions. High speed extraction of the vapours at the source means that the user does not get exposed, and solvent loss is minimized. Capture@Source uses discreet and out of the way vents to intercept the vapors.

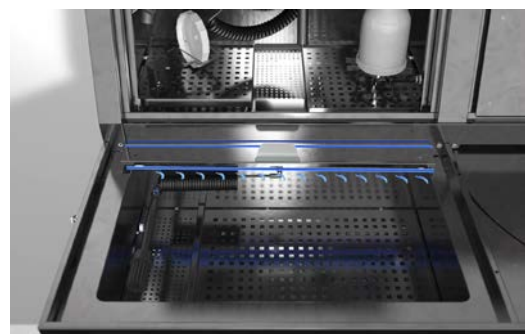

DRESTER CAPTURE@SOURCE VENTILATION

For superior working conditions. Reduces user exposure and solvent loss. These images demonstrates the effectivity of the discreet, high-speed Capture@Source vents.

SAVE MONEY

Use less and waste less solvent

MINIMIZE EXPOSURE

Improve health & safety in the shop

SAFE AND RELIABLE

ATEX category 2 / zone 1



All washing areas have easily removable working platforms. A breeze to clean with smooth welded edges inside.

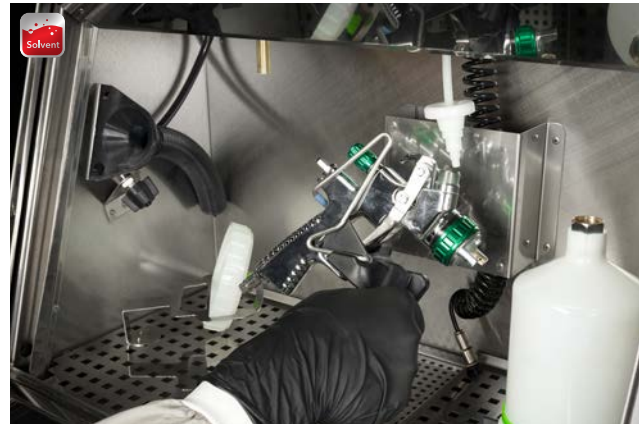

Custom nozzle configurations and spray patterns deliver superior cleaning results. Removable and easy-to-clean components. Spray nozzle with fresh solvent for rinsing.



Flow-through brush and rinse gun with recycled waterborne solution. (Tap water optional.) The filtration process separates and dries paint residues to simplify waste handling.



Front cover slides up and rests in service position to allow easy access to solvent/water drums.

High speed extraction of vapours from source

[New advanced auto-wash nozzle design](#)

All-stainless solvent wash areas, easy to keep clean

[Reduce solvent usage and waste removal costs](#)

Save energy - minimized ventilation with higher air speed



CAPTURE@SOURCE IN ALL MODELS

- Models with 2-4 washing stations, for solvent, water or both combined.
- Auto-wash in the top compartment and manual wash in the lower area.
- Maximize your washing power, use both at the same time!



ACE QUATTRO



ACE TRIPLE



ACE DOUBLE

ART. NO. / NAME	(C) COMBO* (S) SOLVENT (A) AQUA**	WASHING STATIONS	WEIGHT	WIDTH	HEIGHT	MAX DEPTH	DEPTH AT FLOOR
DG4C / Ace Quattro C	COMBO	4	100 kg (220 lb)	1190 mm (46.85")	1488 mm (58.58")	675 mm (26.57")	621 mm (24.45")
DG4S / Ace Quattro S	SOLVENT	4					
DG3C / Ace Triple C	COMBO	3	90 kg (140 lb)				
DG2C / Ace Double C	COMBO	2	80 kg (176 lb)	840 mm (33.07")			
DG2S / Ace Double S	SOLVENT	2					
DG2A / Ace Double A	AQUA	2					

*COMBO= SOLVENT AND WATERBORNE SOLUTION

**AQUA= WATERBORNE SOLUTION

ALL MODELS:
Compressed air required: 7-12 bar (110-180 psi)
Ventilation built-in: 360m ³ /h (4S/4C) (212 cfm) with 10 m extension
Designed for 60 up to litre drums (15.8 US Gal.) (2C: 25 litre / 6.6 US Gal.)
Extractor diameter: 100 mm (4")
Pump certification: ATEX cat 1/zone 0, for solvent groups IIA and IIB
Warranty: 3 years
ATEX Category: cat 2 / zone 1
Stainless steel version available: Yes Art. No. Dlx

Ace features

	 ACE DOUBLE C DG2C	 ACE DOUBLE S DG2S	 ACE DOUBLE A DG2A	 ACE TRIPLE C DG3C	 ACE QUATTRO S DG4S	 ACE QUATTRO C DG4C
1. Unique magnetic gun holder, patent approved	•	•	•	•	•	•
2. Funnel for blow-out	•	•	•	•	•	•
3. Air gun for drying	•	•	•	•	•	•
4. Air supply line	•	•	•	•	•	•
5. Pneumatic extractor	•	•	•	•	•	•
6. Can be connected to Drester Recycler through a Docking unit (RDX)	•	•	-	•	•	•
7. Fixed rinse nozzle with clean solvent	•	•	-	•	•	•
8. Automatic cleaning with recirculating solvent	•	•	-	•	•	•
9. Automatic rinsing with clean solvent	-	•	-	•	•	•
10. Flow-through brush with recirculating solvent	-	•	-	•	•	•
11. Flow-through brush with recycled waterborne solution	•	-	•	•	-	•
12. Automatic cleaning with recirculating waterborne solution	-	-	•	-	-	•
13. Rinse gun with recycled waterborne solution or tap water*	Tap water optional*	-	Tap water optional*	Tap water optional*	-	Tap water optional*
14. Automatic agitation when flocculating	•	-	•	•	-	•
15. Dual filter system for recycled water	•	-	•	•	-	•
16. Time extension kit - Universal solvent system	•	•	•	•	•	•
17. Lid manual water station	Optional					

* Optional watervalue kit for tap water connection including automatic evacuation of filtrate container. Pre-installed: add „T“ to item number, e.g. DG2C-T.





Details of model Ace COMBO:

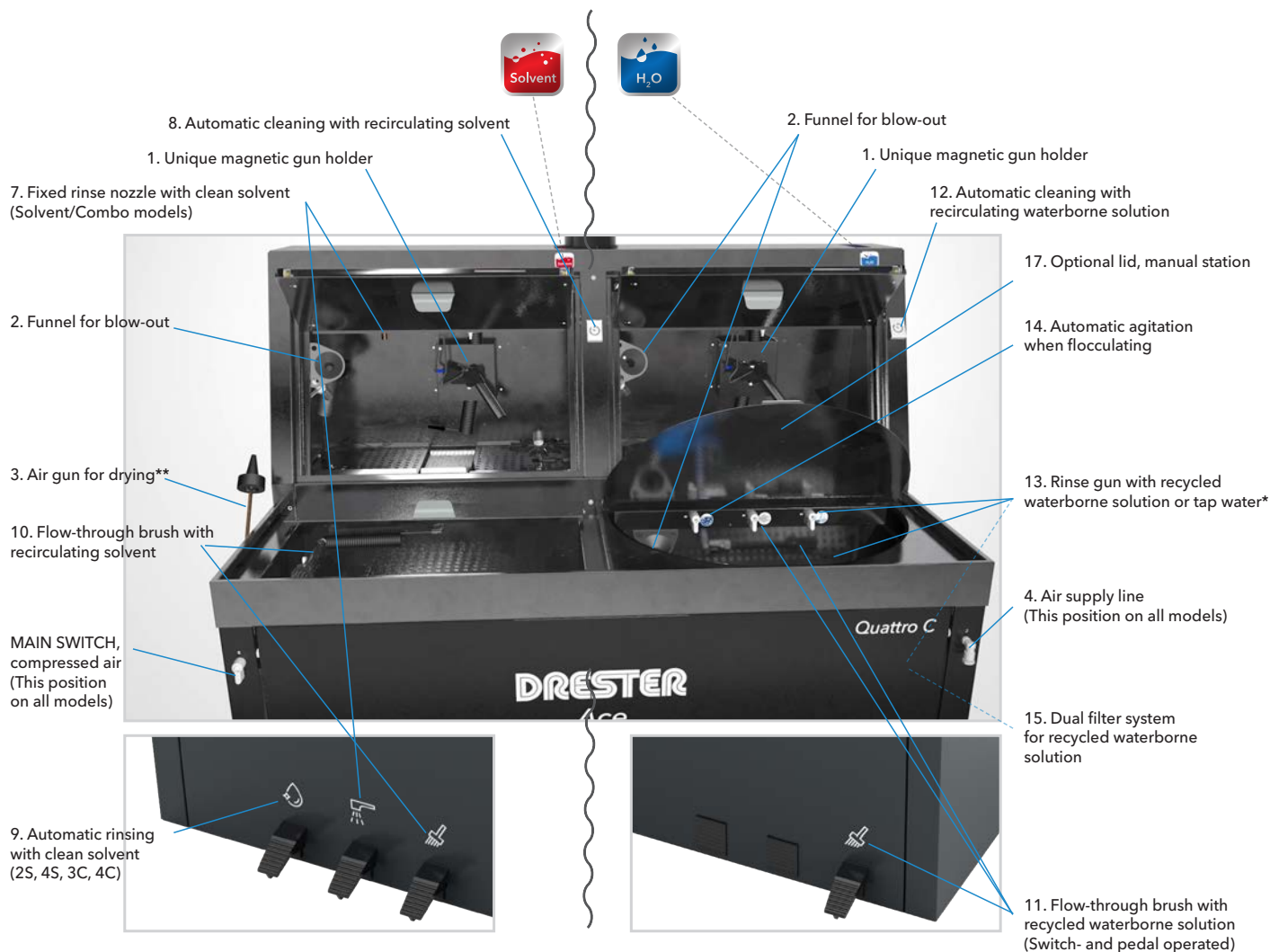

* Optional watervale kit for tap water connection including automatic evacuation of filtrate container. Pre-installed: add „T“ to item number, e.g. DG2C-T.
 ** (3) Airgun with magnetic attachment can be placed on either side of Ace spraygun cleaner.





DRESTER CLASSICS

Compact and user-friendly spray gun cleaners with outstanding cleaning performance

The Drester Classics by Hedson have been on the market for decades, which says a lot about their performance and value for the money. They are still very high in demand and remain a reliable choice. It has been dominating the water-borne cleaning market, and with its robustness and user-friendliness it still has no equivalent. The automatic Classics, for solvent, takes gravity-fed guns as well as old-style suction-fed guns.

- 3 YEARS WARRANTY ON PUMPS
- ROUND SINK WITH NO WELDING SEAMS FOR EASY MAINTENANCE
- MANUAL AND/OR AUTOMATIC CLEANING
- WASHES ALL TYPES OF GUNS - SUCTION OR GRAVITY FED GUNS

DRESTER CLASSIC 1000

Manual spray gun cleaner with brush and high pressure rinse gun

- Prepared for different set-ups depending on paint brand
- Foot operated for hands-free operation
- Built-in waste recycling system



DIMENSIONS

Height	1220 mm (48")
Diameter	Ø 590 mm (23")
Weight	24 kg



DRESTER 1000

Compressed air needed	Flow through brush	Liquid volume of machine	Part.no.
5-12 bar (80-180 psi) 100 l/min (4 cfm)	1,5-2 l/min	35 l / 10 gallons	1000

DRESTER CLASSIC 1050

Manual spray gun cleaner with re-circulating water

- Pre-wash brush and a rinse gun fed with recycled water
- Manual cleaning with brush and high pressure rinse gun
- Quick connect whip line for blowing out the spray gun paint channel



DIMENSIONS

Height	1050 mm (41")
Diameter	Ø 590 mm (23")
Weight	21 kg



DRESTER 1050

Compressed air needed	Flow through brush	Liquid volume of machine	Part.no.
5-12 bar (80-180 psi) 100 l/min (4 cfm)	1,5-2 l/min	35 l / 10 gallons	1050



DRESTER CLASSIC 2600

Efficient and solvent saving manual clean rinse

- Manual cleaning with flow-through brush
- Foot operated for hands-free operation
- Manual clean rinse with venturi nozzle



DIMENSIONS

Height	990 mm (39")
Diameter	Ø 563 mm (22")
Weight	30 kg (66 lb)

DRESTER CLASSIC 2600

Compressed air needed	Ventilation capacity required	Extractor diameter	Part.no.
5-12 bar (80-180 psi) 250 l/min (9 cfm)	140 m³/h / 82 cfm (15 m extension) 180 m³/h / 106 cfm (5 m extension)	125 mm (5")	2600 (Blue) 2600-INOX (Stainless steel)



DRESTER CLASSIC 3600

Automatic spray gun cleaner with manual clean rinse

- Automatic cleaning with re-circulating solvent
- Manual rinse with clean solvent
- Equipped with air pressure regulator and water trap for durability



DIMENSIONS

Height	990 mm (39")
Diameter	Ø 563 mm (22")
Weight	30 kg (66 lb)

DRESTER 3600

Compressed air needed	Ventilation capacity required	Extractor diameter	Part.no.
7-12 bar (110-180 psi) 250 l/min (9 cfm)	140 m³/h / 82 cfm (15 m extension) 180 m³/h / 106 cfm (5 m extension)	125 mm (5")	3600 (Blue) 3600-INOX (Stainless steel)



DRESTER CLASSIC 8000

Automatic spray gun cleaner with automatic and manual clean rinse

- Can be used with conventional or water-based paints
- Automatic cleaning with re-circulating solvent
- Automatic or manual rinse with clean solvent



DIMENSIONS

Height	990 mm (39")
Diameter	Ø 563 mm (22")
Weight	33 kg (73 lb)

DRESTER 8000

Compressed air needed	Ventilation capacity required	Extractor diameter	Part.no.
7-12 bar (110-180 psi) 250 l/min (9 cfm)	140 m³/h / 82 cfm (15 m extension) 180 m³/h / 106 cfm (5 m extension)	125 mm (5")	8000-A 8000-B (with collecting tray base)



DRESTER QUICKRINSE

Efficient and user friendly pneumatic rinsing spray gun cleaner for use with disposable cup systems

The Drester QuickRinse by Hedson has been developed to provide quick, thorough spray gun cleaning for water or solvent paints, especially for use with disposable cup system.

- For all disposable cup system
- Perfectly clean spray gun in 10 seconds gives time and cost savings
- High-pressure cleaning for safe colour changes

Installation is simple and easy, either with the use of magnets for attachment to the booth or mixing room walls or more permanently with zip screws. Save time by keeping the spray gun cleaner close to the paint job.

DRESTER QR-10

Manual spray gun cleaner for water-borne paints

- Can be placed inside the spray booth
- Equipped with a diaphragm pump
- Automatic rinsing with clean solvent or water



DIMENSIONS

Height	645 mm (25.5")
Width	535 mm (21.0")
Depth	263 mm (10.5")
Weight	12,5 kg (27 lb)



DRESTER QR-10		Compressed air needed	Pump capacity	Permitted solvents	Liquid volume of machine	Part.no.
5-12 bar (80-180 psi)	2 l/min	100 l/min (4 cfm)	Water or water-borne solvents	5+5 litre	QR-10	

DRESTER QR-20

Manual spray gun cleaner for solvent based paints

- Also designed for cleaning with water, or water-based solvents
- Easy installation anywhere in the workshop



DIMENSIONS

Height	461 mm (18.1")
Width	306 mm (12.1")
Depth	273 mm (10.8")
Weight	6 kg (13.2 lb)



DRESTER QR-20		Compressed air needed	Pump capacity	Permitted solvents	Liquid volume of machine	Part.no.
5-12 bar (80-180 psi)	2 l/min	100 l/min (4 cfm)	Solvent and solvent mixtures	Amount of wash fluid depending on chosen size of container	QR-20	

DRESTER QR-TT

Manual spray gun cleaner for both water-borne and solvent based paints

- Can be placed inside the spray booth if water-borne solvents are used
- Easy installation anywhere in the workshop



DIMENSIONS

Height	667 mm (26.3")
Width	565 mm (22.2")
Depth	264 mm (10.4")
Weight	16 kg (32 lb)



DRESTER QR-TT		Compressed air needed	Pump capacity	Permitted solvents	Liquid volume of machine	Part.no.
5-12 bar (80-180 psi)	2 l/min	100 l/min (4 cfm)	LEFT BOX: Water or water-based solvents RIGHT BOX: Solvents and solvent mixtures	3 l/solvent (amount of water depending on chosen size of container)	QR-TT	



DRESTER DYNAMIC TRIPLE

Better spray gun cleaning performance with an environmentally friendly closed system of handling solvents

The transfer of the solvents between the spray gun cleaner and the recycler is fully automated; the dirty, heavy and hazardous manual solvent handling is eliminated and at the same time the equipment and floor in the workshop stays clean. Instantly after the transfer of solvents, access to clean solvent in the spray gun cleaner is available.

The system allows for the units to be placed either close together or in separate rooms up to 25 meters (subject to local fire legislation).

The convenient operation of the Drester Dynamic Triple by Hedson system encourages to run the system often.

This keeps the solvent in the spray gun cleaner in better condition, resulting in improved spray gun cleaning performance. The consumption of solvent is reduced, the waste of solvent is kept to a minimum and costs are cut dramatically.

- Reduced solvent consumption
- Improved spray gun cleaning performance
- Fully automated transfer between the spray gun cleaner and the recycler

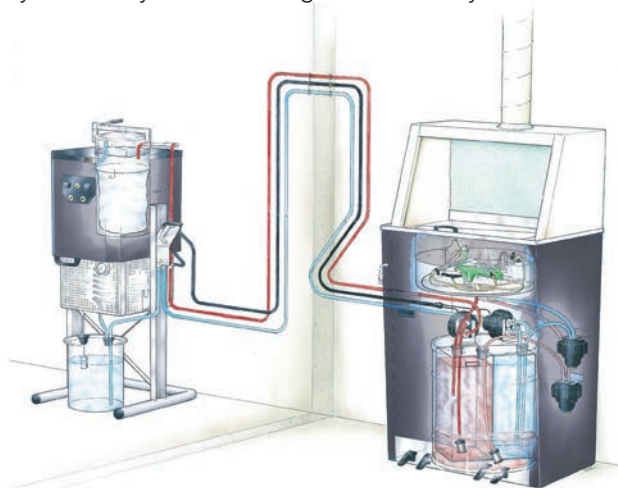

TO SETUP A DRESTER DYNAMIC TRIPLE YOU NEED THE FOLLOWING UNITS

- 1 DRESTER SPRAY GUN CLEANER
- 2 DOCKING UNIT
- 3 RECYCLER



See the process here:

DRESTER RDX - DOCKING UNIT

- For solvent transfer in the Drester Dynamic Triple
- Includes an overflow protection.
- Can be placed inside the spray gun cleaners

DIMENSIONS

Height	590 mm (23")
Width	1610 mm (63")
Max. Depth	120 mm (47")
Weight	67 kg (148 lb)



DRESTER DOCKING UNIT

Compressed air needed	Solvent capacity	Pump capacity	Liquid pressure	Part.no.
Clean, dry air at 3-10 bar	Max. 80 litres	10 l/minutes	2 bar	RDX-8012 Drester 2600, 3600 & 8000 RDX-9012 Drester Boxer Solvent, X-Series Manual

DRESTER 120 - RECYCLER

- A solvent recycler in the Drester Dynamic Triple
- Recovers and recycles the solvent used in the spray gun cleaner
- Can also be used as a stand-alone product

DIMENSIONS

Height	700 mm (17.5")
Diameter	Ø 500 mm (19.5")
Weight	21 kg (46 lb)



DRESTER RECYCLER

Type of solvents distillable	Boiler capacity	Residues discharge	Condensation system	Condensate material	Time/cycle	Voltage	Part.no.
Thinner type	12 litres	Plastic bag	By air	Stainless steel	3-4 hours	200-240 V single Phase 50 or 60Hz	DR-120-A

DRESTER WASTE MANAGEMENT

Safe and efficient way to get rid of paint residues and waste in the workshop

- Two compartments for easy separation of waste
- Equipped with two funnels with grids, for cans to be left to drain
- Flexible usage



DRESTER WM-90-1
Two compartments for liquid waste



DRESTER WM-90-2
One compartment for liquid and one for solid waste



DRESTER WM-90-3
Two compartments for solid waste



DRESTER WASTE MANAGEMENT

Compressed air needed	Extractor flange diameter	Part.no.
7-12 bar (110-180 psi) 450 l/min (16 cfm) (if extraction is desired)	125 mm (5") with flange (part.no. 10187)	WM-90-1 WM-90-2 WM-90-3

DIMENSIONS

Height	1025 mm (40")
- with hood	1470 mm (58")
- with hood & airvent	2230 mm (89")
Width	780 mm (31")
Depth at the floor	570 mm (23")
Weight	42 kg (x lb)

DRESTER MIXING TABLE

Keeps the mixing room structured

- Smart storage which gives efficient work flow
- Basic model with one shelf underneath
- Available in powder coated or stainless finish



DRESTER MIXING TABLE

Airvent diameters	Weight	Width	Height	Max. depth	Part.no.
14010 Ø100 mm	Basic model	30,0 kg	1200 mm	Basic model 930 mm	MT-120 (powder coated)
14020/14040 Ø125 mm	with slot extraction & airvent	36,5 kg		With slot extraction 1110 mm	
	with hood & airvent	45,0 kg		With hood 1470 mm	
				Working height 905 mm	

HERKULES LACKY TABLE

Table with a lot of storage space suitable for the mixing room

- Storage space for painting materials and tools
- Lowered working surface
- Outflow tunnel and optimum solvent extraction



HERKULES LACKY TABLE

Width	Overall Height	Depth	Part.no.
1200 mm	1395 mm	650 mm	LT-05 ¹
1800 mm	1395 mm	650 mm	LT-06 ¹

¹ Paper roll holder and extraction system available as accessories.



DRESTER SPRAY GUN CLEANERS

Basic features

	CLASSIC				
	1000	1050	2600	3600	8000
Manual wash with re-circulating solvent/recycled water	•	•	•		•
Manual clean rinse	•	•	•	•	•
Foot-pedal operated					
Hand-switch operated					
Air connection and funnel for spray out			•	•	•
Air gun for drying spray gun		•	•		
Extraction unit (Airvent) included			•	•	•
Number of pumps	1	1	1	1	2
3-year warranty on diaphragm pumps	•	•	•	•	•
Can be connected to Drester 120 with the Docking Unit RDX			•	•	•
Can be used with water-borne paints	•	•			•
Specifically adapted for all water-borne paint systems	•	•			
Cleaning brush	•	•	•		
Rinse gun with nozzle for high pressure cleaning of paint channel	•	•			
Automatic agitation during flocculation	•	•			
Dual filter system for separation of paint sludge	•	•			
Automatic evacuation of filtrate container	•				
Nozzle for quick cleaning of paint channels			•		
ATEX category	3	3	2	2	2

DRESTER CONSUMABLES



FILTERS	
Part.no.	R8701 - Main filter (standard) R8702 - Pre-filter (always to be used) Delivered in 5 pcs.
TO BE USED IN FOLLOWING DRESTER GUN CLEANERS	
Part.no.	Description
DB22A	Drester Boxer Aqua
DB22C	Drester Boxer Double Combo
DB33C	Drester Boxer Triple Combo
DB44C	Drester Boxer Quattro Combo
1000	Drester Classics 1000
1050	Drester Classics 1050

AQUASOLVE	
Part.no.	230120 Delivered in 1 L x 12 pcs
TO BE USED IN FOLLOWING DRESTER GUN CLEANERS	
Part.no.	Description
DB22A	Drester Boxer Aqua
DB22C	Drester Boxer Double Combo
DB33C	Drester Boxer Triple Combo
DB44C	Drester Boxer Quattro Combo
1000	Drester Classics 1000
1050	Drester Classics 1050
QR-10	Drester QuickRinse, water
QR-TT	Drester QuickRinse, water & solvent

FLOCCULATION POWDER	
Part.no.	9211 Delivered in can / 1,5 kg.
TO BE USED IN FOLLOWING DRESTER GUN CLEANERS	
Part.no.	Description
DB22A	Drester Boxer Aqua
DB22C	Drester Boxer Double Combo
DB33C	Drester Boxer Triple Combo
DB44C	Drester Boxer Quattro Combo
1000	Drester Classics 1000
1050	Drester Classics 1050



HERKULES LIFTING EQUIPMENT

Why choose a Herkules lift?

Pneumatic technology

- Faster than hydraulic systems
- Silicone- & oil free to prevent damages to paint jobs
- No electricity needed

Ergonomic working process

- 85% of damages are located beneath the window, so lifting is always an ergonomic advantage
- Stepless lifting heights - safe and smooth

Advanced flexibility

- Lifting on wheels, lifting on chassis or a combination of both
- Installation on-ground, in-ground or integration in existing rail systems
- Mobile lifts or transport system for lifts

Optimized efficiency

- Fast lifting and transport of vehicles
- Optimal view on damages for best repair quality
- Yearly checks of lifts can be done by owner

High-quality engineering

- User-friendly
- Robust and durable due to 40 years of experience
- Easy to install in the workshop

Qualified technical customer support

- Contact for technical service
- Spare parts even for older lifts

LIFTING ON WHEELS

These lifts are wheel supported for easy access to damaged areas on the vehicles.

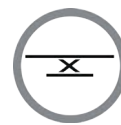

LIFTING ON CHASSIS

These lifts are chassis supported for a wheel free operation.



COMBINATION OF BOTH

These lifts are a combination of both wheel and chassis supported lifts, one lift - two possibilities.

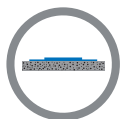
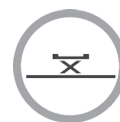
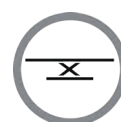

ON-GROUND

Simply fix with screws and dowels, and the lift is ready for immediate use.



IN-GROUND

In-ground installation to concrete or grids.



ON-RAILS

Integration in existing rail system



THE INNOVATIVE LIFT FOR THE CLEVER PAINT SHOP OWNER

The new generation of Herkules lifts is characterized by a functional and well thought-out design.

Many innovative details help simplify everyday work in the paint shop. Despite the compact design, which also characterizes the previous Herkules lifts, longer and heavier vehicles can also be lifted on the new AirgoMatic Pro 3513 thanks to intelligent roll-off protection and a lifting capacity of 3.5 t. New technology makes the DUO function safer and easier to use than ever before.



Herkules AirgoMatic Pro 3513 -11

Benefits

- Lifting capacity of 3.5 t for lifting vans and heavy electric vehicles
- Lifting height 1300 mm for ergonomic work
- Space-saving and elegant design
- Innovative roll-off protection; vehicles with longer wheelbases also fit on the lift without any problems
- Easy to use thanks to easily accessible supports
- User-friendly slider for the duo function for lifting on chassis
 - Easy and safe to use with immediate visual check
 - New mushroom head function, button disappears when driving over
- Modular pneumatics with optional features
 - Lifting limiter, which can also be deactivated by pressing a button
 - Forced venting of the air bellows, residual air in the bellows is avoided, thus no damage to the underbody of the vehicle when driving down
- Low construction height of 10 cm, for cars with low ground clearance
- Long arms, so lifting points are easily accessible for large and very small vehicles
- Standard CE stop according to the DIN standard, automatic stop when lowering at 15 cm above the ground, when lowering to the ground an acoustic warning signal sounds

HERKULES AIRGOMATIC PRO 3513

Versatile lift for the workshop or the paint booth

Benefits

- Easy access to all areas of the vehicle thanks to fold-down runway
- Versions for installation on-ground or in-ground
- All lifts are equipped with CE stops
- Optional forced venting of the air bellows
- Optionally available with ATEX certification.



Herkules Airgomatic Pro 3513-11

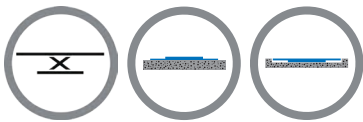

DIMENSIONS

Lifting height (on-ground/ in-ground)	1300/1150 mm
Overdrive height (on-ground)	100 mm
Pit depth (in-ground)	150 mm

HERKULES AIRGOMATIC PRO 3513

Part-no.	Lifting capacity	Air supply	Wheel base (max.)	Weight	Installation
HLS3513-11	3,5 t	6-8 bar	3700 mm	997 kg	On-ground with CE-Stop*
HLS3513-14	3,5 t	6-8 bar	3700 mm	1017 kg	In-ground with CE-Stop*

*Sicherheitsstopp mit Warnton zur Vermeidung von Fußverletzungen

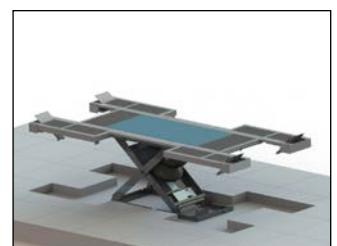
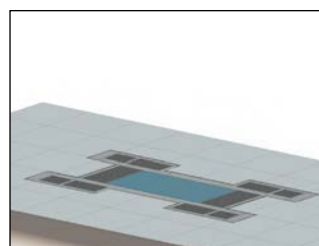



Innovative roll-off protection

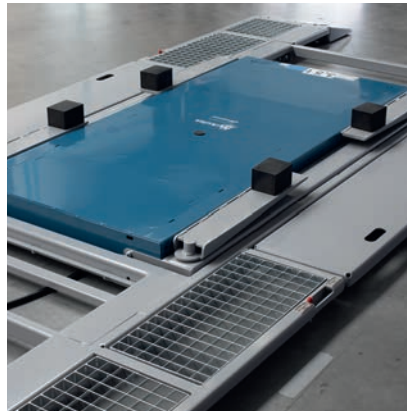

Extremely flat design

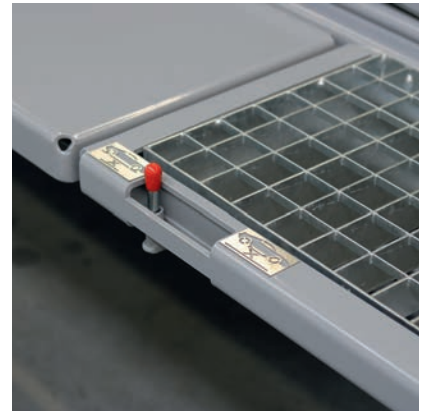

User-friendly slider

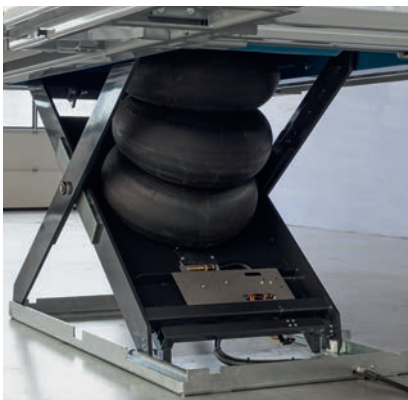

The core element of every pneumatic lift - the air-bellow

Benefits for assembly and maintenance

- Simple assembly thanks to useful assembly aids
- Easier conversion from on-ground lift to in ground and vice versa
- Air bellows easily replaceable
- Easy maintenance of the sliding blocks

Duo or not Duo - that is the question



The Herkules AirgoMatic Pro 3513 DUO can lift vehicles on chassis or alternatively standing on wheels.

The Herkules AirgoMatic Pro 3513 can lift a car standing on its wheels.

HERKULES AIRGOMATIC PRO 3513 DUO

Flexible lift for all requirements in the workshop and in the paint booth

Benefits

- Arms same height as main body for the on-ground installed version, therefore low installation height of 10 cm, for cars with low ground clearance
- User-friendly slider for the duo function for lifting on chassis
 - Easy and safe to use with immediate visual check
 - New mushroom head function, button disappears when driving over
- All lifts are equipped with CE stops
- Long arms, so lifting points are easily accessible for large and very small vehicles



Herkules AirgoMatic Pro 3513 DUO-11
- even big vehicles can be lifted

DIMENSIONS

Lifting height (on-ground/ in-ground)	1300/1150 mm
Overdrive height (on-ground)	100 mm
Pit depth (in-ground)	150 mm

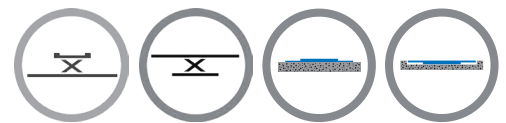

HERKULES AIRGOMATIC PRO 3513 DUO

Part.-no.	Lifting capacity	Air supply	Wheel base (max.)	Weight	Installation
HLS3513DUO-11	3,5 t	6-8 bar	3700 mm	1110 kg	On-ground with CE-Stop*
HLS3513DUO-14	3,5 t	6-8 bar	3700 mm	1129 kg	In-Ground with CE-Stop*

*Safety stop with audible alarm to prevent foot injuries

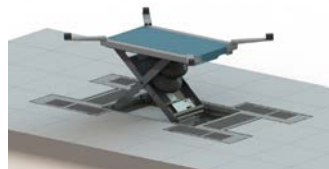



HERKULES AIRGOMATIC BIG-DUO

Extra long lift for special requirements in the body and paint shop

Benefits

- Long wheel stand to lift extra long vehicles for special purposes, like ambulances.
- Extra long arms



Herkules AirgoMatic BIG DUO-14 -
to lift extra long vehicles

DIMENSIONS

Lifting height	1300 mm
Overdrive height (on-ground)	110 mm
Pit depth (in-ground)	150 mm

HERKULES AIRGOMATIC BIG DUO

Part.no.	Lifting capacity	Air supply	Wheel base (max.)	Weight	Installation
HLS 3213-DUO-BIG-11	3 t	8 bar	4500 mm	1275 kg	On-ground
HLS 3213-DUO-BIG-14	3 t	8 bar	4500 mm	1275 kg	In-ground
HLS 3213-DUO-BIG-16	3 t	8 bar	4500 mm	1275 kg	In-ground with CE-Stop*

*Sicherheitsstopp mit Warnton zur Vermeidung von Fußverletzungen

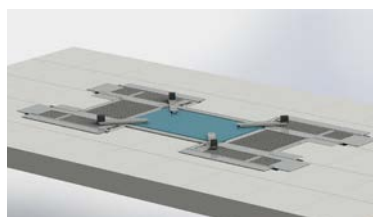

THE RIGHT HERKULES LIFT FOR EVERY REQUIREMENT

Overview over lifting height, lifting capacity and wheel base for all on-ground Herkules lifts with wheel stand

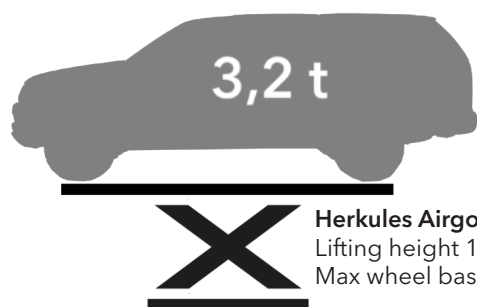

Herkules AirgoMatic 3213-11 on-ground
Lifting height 1300 mm
Max wheel base 3500 mm

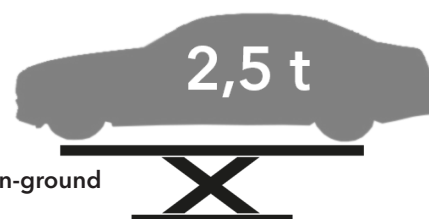

Herkules HLS 1200-11 on-ground
Lifting height 930 mm
Max wheel base 3200 mm

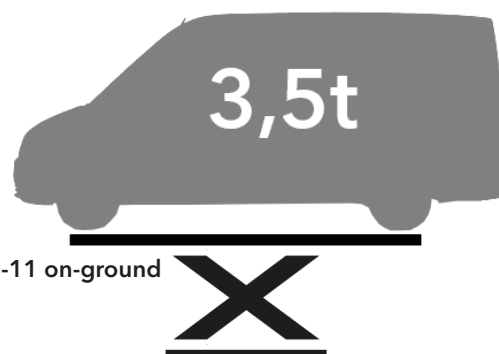

Herkules AirgoMatic Pro 3513-11 on-ground
lifting height 1300 mm
Max wheel base 3700 mm

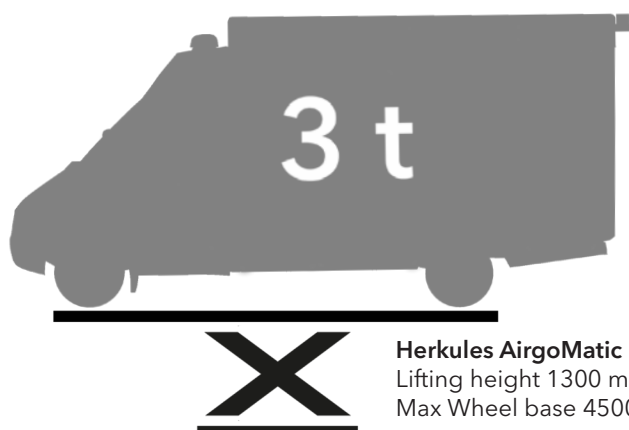

Herkules AirgoMatic Big Duo-11 on-ground
Lifting height 1300 mm
Max Wheel base 4500 mm

Lift	Part.-no.	Lifting capacity	Wheel base (max)	Lifting height
Herkules HLS 1200-11 on-ground	HLS1200-11	2,5 t	3200 mm	930 mm
Herkules AirgoMatic 3213 -11 aufliegend	HLS3213-11	3,2 t	3500 mm	1300 mm
Herkules AirgoMatic Pro 3513 -11 aufliegend	HLS3513-11	3,5 t	3700 mm	1300 mm
Herkules AirgoMatic Big Duo-11 aufliegend	HLS 3213-DUO-BIG-11	3 t	4500 mm	1300 mm



HERKULES AIRGOMATIC HLS 3213

For ergonomic lifting of all common vehicle model

- 3.2 tons lifting capacity
- 1300 mm lifting height
- For a wheelbase up to 3500 mm
- Fold-down driveover ramps

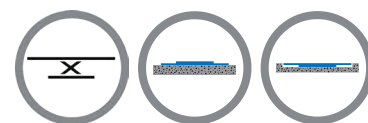

DIMENSIONS

Lifting height (on-ground/ in-ground)	1300/1140 mm
Overdrive height (on-ground)	110 mm
Pit depth (in-ground)	160 mm

HERKULES AIRGOMATIC HLS 3213

Part.no.	Lifting capacity	Air supply	Wheel base (min./ max.)	Lifting time	Lowering time	Weight	Installation
HLS 3213-11	3,2 t	8 bar	1600/3500 mm	ca. 25 s*	ca. 30 s*	925 kg	On-ground
HLS 3213-14	3,2 t	8 bar	1600/3300 mm	ca. 25 s*	ca. 30 s*	865 kg	In-ground
HLS 3213-16	3,2 t	8 bar	1600/3300 mm	ca. 25 s*	ca. 30 s*	865 kg	In-ground, CE-Stop**
HLS 3213-17	3,2 t	8 bar	1600/3500 mm	ca. 25 s*	ca. 30 s*	950 kg	Transmobil (HLT-06)

* With empty lift

**Safety stop with audible alarm to prevent foot injuries

HERKULES HLS 1200

A compact lift for space-saving requirements

- 2.5 tons lifting capacity
- Easy to install in the workshop
- Stepless lifting heights for ergonomic working position

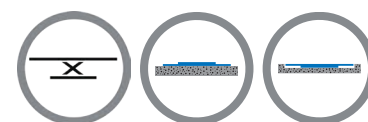

DIMENSIONS

Lifting height (on-ground/in-ground)	930/805 mm
Overdrive height (on-ground)	110 mm
Pit depth (in-ground)	125 mm

HERKULES HLS 1200

Part.no.	Lifting capacity	Air supply	Wheel base (min./ max.)	Lifting time	Lowering time	Weight	Installation
HLS 1200-11	2,5 t	8 bar	1500/3200 mm	ca. 25 s*	ca. 30 s*	750 kg	On-ground
HLS 1200-14	2,5 t	8 bar	1500/3000 mm	ca. 25 s*	ca. 30 s*	750 kg	In-ground
HLS 1200-16	2,5 t	8 bar	1500/3000 mm	ca. 25 s*	ca. 30 s*	750 kg	In-ground, CE-Stop**
HLS 1200-17	2,5 t	8 bar	1500/3200 mm	ca. 25 s*	ca. 30 s*	800 kg	Transmobil (HLT-3)

* With empty lift

**Safety stop with audible alarm to prevent foot injuries



HERKULES AIRGOMATIC 3213 DUO

Adaptive lift for most diverse requirements

- 3.2 tons lifting capacity
- 1300 mm lifting height
- Lifting on wheel or on chassis
- Flat arms and hightened drive ways

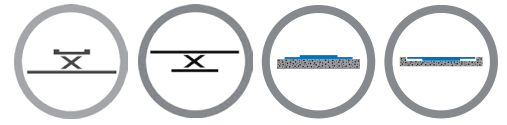

ALTERNATIV



DIMENSIONS

Lifting height (on-ground/in-ground)	1300/1140 mm
Overdrive height (on-ground)	110 mm
Pit depth (in-ground)	160 mm

HERKULES AIRGOMATIC 3213 DUO

Part.no.	Lifting capacity	Air supply	Wheel base (min./max.)	Lifting time	Lowering time	Weight	Installation
HLS 3213-DUO-11	3,2 t	8 bar	1600/3500 mm	ca. 25 s*	ca. 30 s*	1050 kg	On-ground
HLS 3213-DUO-14	3,2 t	8 bar	1600/3300 mm	ca. 25 s*	ca. 30 s*	955 kg	In-ground
HLS 3213-DUO-16	3,2 t	8 bar	1600/3300 mm	ca. 25 s*	ca. 30 s*	955 kg	In-ground, CE-Stop**
HLS 3213-DUO-17	3,2 t	8 bar	1600/3500 mm	ca. 25 s*	ca. 30 s*	1070 kg	Transmobil (HLT-06)

*With empty lift

**Safety stop with audible alarm to prevent foot injuries

HERKULES HLS 1200 DUO

User-friendly and variable lift even for confined spaces

- 2.5 tons lifting capacity
- Lifting on wheel or on chassis
- Installation on ground or in ground

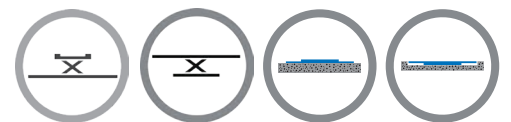

ALTERNATIV



DIMENSIONS

Lifting height (on-ground/in-ground)	930/825 mm
Overdrive height (on-ground)	110 mm
Pit depth (in-ground)	115 mm

HERKULES HLS 1200 DUO

Part.no.	Lifting capacity	Air supply	Wheel base (min./max.)	Lifting time	Lowering time	Weight	Installation
HLS 1200-DUO-11	2,5 t	8 bar	1500/3200 mm	ca. 25 s*	ca. 30 s*	850 kg	On-ground
HLS 1200-DUO-14	2,5 t	8 bar	1500/3000 mm	ca. 25 s*	ca. 30 s*	850 kg	In-ground
HLS 1200-DUO-16	2,5 t	8 bar	1500/3000 mm	ca. 25 s*	ca. 30 s*	850 kg	In-ground, CE-Stop**
HLS 1200-DUO-17	2,5 t	8 bar	1500/3200 mm	ca. 25 s*	ca. 30 s*	850 kg	Transmobil (HLT-03)

*With empty lift

**Safety stop with audible alarm to prevent foot injuries



HERKULES HLO

Lift for existing rail system*

- for transportation between spraying and drying booths



- Lifting on wheels
- Vehicles can be moved sideways
- Installation in-ground



*Trolleys for railsystem not included

HERKULES HLO				
Part.no.	Lifting capacity	Air supply	Lifting height	Installation
HLO 01	2,5 t	8 bar	800 mm	Bodeneben
HLO-3213	3,2 t	8 bar	1150 mm	Bodeneben

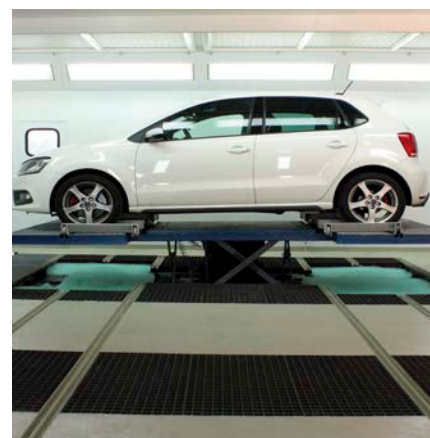

HERKULES HM 1100 AND 1200

A fast and space saving lift

- 2.8 tons lifting capacity
- Horizontal moveable swivel arms - safe fixing of wide vehicles
- No installation - ready to use immediately
- Movable with an optional shaft (Herkules HM 1100-01)

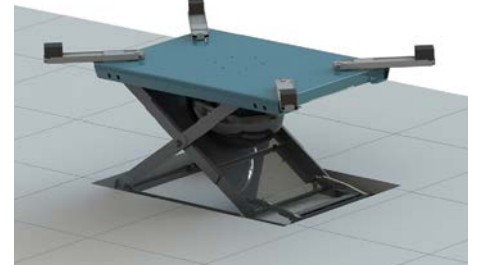
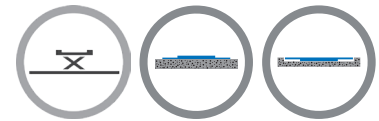

Herkules HM 1200-04 in-ground



Herkules HM 1100-01 on-ground

DIMENSIONS HERKULES HM 1200-04

Lifting height (in-ground)	825 mm
Overdrive height (in-ground)	46 mm
Pit depth (in-ground)	115 mm

DIMENSIONS HERKULES HM 1100-01

Lifting height (on-ground)	930 mm
Overdrive height (on-ground)	115 mm

HERKULES HM 1100

Part.no.	Lifting capacity	Air supply	Lifting time	Lowering time	Weight	Installation
HM 1100-01	2,8 t	8 bar	ca. 15 s***	ca. 20 s (empty lift)	510 kg	On-ground
HM 1200-04	2,8 t	8 bar	ca. 15 s***	ca. 20 s (empty lift)	510 kg	In-ground, with 4 rubberblock 800-105

HERKULES HM 3213 AND HM 3513

In-ground lift with high lifting capacity

- 3,2 t Tragkraft (HM 3213)
- 3,5 t Tragkraft (HM 3513)
- Movable Swivelarms for the secure lifting of large vehicle

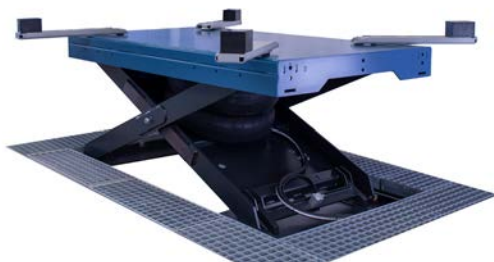

Herkules HM 3213-04 in-ground



Herkules HM 3513-04 in-ground

HERKULES HM 3213 / HM 3513

Part.no.	Lifting capacity	Air supply	Weight	Installation
HM 3213-04	3,2 t	8 bar	550 kg	In-ground
HM 3213-06	3,2 t	8 bar	550 kg	In-ground with CE-Stop
HM 3513-04	3,5 t	8 bar		In-ground with CE-Stop

DIMENSIONS HERKULES HM 3213 / HM 3513

Lifting height	1150 mm
Pit depth HM3213	160 mm
Pit depth HM3513	150 mm

HERKULES K700

A versatile lift for tire service workshops

- 2.8 tons lifting capacity
- No installation - ready to use immediately
- The swivel arms reach easily the vehicle's original lifting points
- lifting points
- Rubber blocks can be used on swivel arms or on main body to lift the vehicle

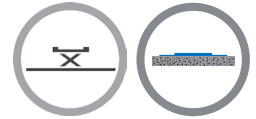

930 mm
lifting height



Lifting on main body



HERKULES K700

Part.-no.	Lifting capacity	Air supply	Lifting time	Lowering time	Installation
K 700-45	2,8 t	8 bar	ca. 15 s*	ca. 20 s*	Auf dem Boden

* Ohne Last

DIMENSIONS

lifting height	930 mm
Overdrive height	110 mm
Weight	840 kg



HERKULES LIFTS

Basic features

	HLS 1200-11	HLS 1200-14 / -16	HLS 1200-17	HLS 1200-DUO-11	HLS 1200-DUO-14 / -16	HLS 1200-DUO-17	AirgoMatic 3212-11	AirgoMatic 3212-14 / -16	AirgoMatic 3212-17	AirgoMatic 3212-DUO-11	AirgoMatic 3212-DUO-14 / -16	AirgoMatic 3212-DUO-17	AirgoMatic Pro 3512-11	AirgoMatic Pro 3512-14	AirgoMatic Pro 3512 DUO-11	AirgoMatic Pro 3512 DUO-14	AirgoMatic Big DUO-11	AirgoMatic Big DUO-14	AirgoMatic Big DUO-16	HLQ 01	HLQ 3213	HM 1100-01	HM 1200-04	HM 3213-04	HM 3213-06	HM 3513-04	K700-45	
SCOPE OF DUTIES																												
Paint- and body work	•	•	•	•	•	•	•	•	•	•	•	•	•	•	•	•	•	•	•	•	•	•	•	•	•	•	•	•
Tirework				•	•	•				•	•	•			•	•	•	•	•	•		•	•	•	•	•	•	•
DRIVING SPECIFICATIONS																												
Wheelbase min (dm)	18	18	18	16	16	16	18	18	18	18	18	18	19	19	19	19	18	18	18									
Wheelbase max (dm)	32	30	32	32	30	32	35	33	35	35	33	35	37	37	37	37	45	45	45									
Drive over possibility	(•)	•	(•)	(•)	•	(•)	(•)	•	(•)	(•)	•	(•)	(•)	•	(•)	•	(•)	•	•	•	•	•	•	•	•	•	•	•
LIFTING SPECIFICATIONS																												
Chassis supported				•	•	•				•	•	•			•	•	•	•	•	•		•	•	•	•	•	•	•
Wheel supported	•	•	•	•	•	•	•	•	•	•	•	•	•	•	•	•	•	•	•	•	•	•	•	•	•	•	•	•
TECHNICAL SPECIFICATIONS																												
Lifting Capacity (tons)	2,5	2,5	2,5	2,5	2,5	2,5	3,2	3,2	3,2	3,2	3,2	3,2	3,5	3,5	3,5	3,5	3	3	3	2,5	3,2	2,8	2,8	3,2	3,2	3,5	2,8	
Overdrive height (cm)	11		11	11		11	12		12	12		12	10		10		11				11					11	11	
Pit depth (cm)		11			11			15			15			15		15		15	15	15	12	20		11	15	15		
Lifting height (cm)	93	82	93	93	82	93	130	115	130	130	115	130	130	115	130	115	130	115	115									
Air supply, bar (min/max)	6/8	6/8	6/8	6/8	6/8	6/8	6/8	6/8	6/8	6/8	6/8	6/8	6/8	6/8	6/8	6/8	6/8	6/8	6/8	6/8	6/8	6/8	6/8	6/8	6/8	6/8	6/8	6/8
INSTALLATION SPECIFICATIONS																												
In-ground		•			•			•			•			•		•		•	•	•			•	•	•	•	•	•
On-ground	•		•	•		•	•		•	•		•	•		•		•	•	•	•	•	•	•	•	•	•	•	•
Mobile			•			•			•			•											(•)					
On-rail																				•	•							

Standard • Optional (•)



Herkules HLS 1200	Part-no.
Additional grids for the front end for HLS1200, 2 pieces, incl. support angles, welded	300 - 344
Pit frame (grids), zinc coated	300 - 304
Pit frame (grids), zinc coated, closed on the front sides	300 - 523
Pit frame (concrete), zinc coated	300 - 307
Pit frame (concrete), zinc coated, closed on the front sides	300 - 524
Drive over ramps, 2 pieces, including support angles	300 - 430
Height adjustable support platform, zinc coated	300 - 484
Surcharge for zinc coated lower frame	SVZ - 01

Herkules HLS 1200 DUO	Part-no.
Additional grids for the front end for HLS1200, 2 pieces, incl. support angles + fasteners	300 - 380
Pit frame (grids), zinc coated, closed on the front sides	300 - 323
Pit frame (grids), zinc coated	300 - 522
Pit frame (concrete), zinc coated, closed on the front sides	300 - 326
Pit frame (concrete), zinc coated	300 - 521
Drive over ramps, 2 pieces including clamps	300 - 430
Height adjustable support platform, zinc coated	300 - 484
Surcharge for zinc coated lower frame	SVZ - 01

Herkules Transmobil	Part-no.
Programming console for Transmobile	400 - 218
Trolley for crosswise moving Transmobile	300 - 247
2 pc drive through ramps for version HLS1200-17 / HLS1200-DUO-17	300 - 430
2 pc drive through ramps for version HLS3213-17 / HLS3213-DUO-17	300 - 465

Herkules HLQ	Part-no.
Surcharge for zinc coated lower frame	SVZ - 01

Herkules HM and Herkules K700	Part-no.
Handle and wheels for HM lift	300 - 170 HM
Fitting frame (grids) for HM1100, zinc coated	300 - 318
Fitting frame (concrete) for HM 1100, zinc coated	300 - 204
Surcharge for zinc coated lower frame	SVZ - 01
Rubber blocks 120 x 100 x 30 mm	800 - 104
Rubber blocks 120 x 100 x 80 mm (Standard)	800 - 105
Rubber blocks 120 x 120 x 100 mm	800 - 107
Rubber blocks 160 x 140 x 110 mm	800 - 112
Rubber blocks 220 x 130 x 120 mm	800 - 106

Herkules HLS 3213	Part-no.
Pit frame (grids), zinc coated	300 - 461
Pit frame for floorgrid, front end closed, zinc coated	300 - 478
Pit frame for concrete, zinc coated	300 - 464
Pit frame for concrete, front end closed, zinc coated	300 - 472
Additional grids for the front end for AirgoMatic 3213, 2 pieces, incl. support angles + fasteners	300 - 481
Drive over ramps, 2 pieces incl. clamps	300 - 465
Extended ramps (800 mm instead 300 mm), 2 pieces	300 - 482
Height adjustable support platform, zinc coated	300 - 484
Surcharge for zinc coated lower frame	SVZ - 01
Wheel stands to convert into HLS 3213 DUO-11	AS - HLS3213DUO- 11
Wheel stands to convert into HLS 3213 DUO-14	AS - HLS3213DUO- 14

Herkules HLS 3213 Duo	Part-no.
Pit frame (grids), zinc coated	300 - 457
Pit frame for floorgrid, front end closed, zinc coated	300 - 476
Pit frame (concrete), zinc coated	300 - 460
Pit frame for concrete, front end closed, zinc coated	300 - 474
Additional grids for the front end for AirgoMatic 3213, 2 pieces, incl. support angles + fasteners	300 - 481
Drive over ramps, 2 pieces incl. clamps	300 - 465
Extended ramps (800 mm instead of 300 mm), 2 pieces	300 - 482
Height adjustable support platform, zinc coated	300 - 484
Surcharge for zinc coated lower frame	SVZ - 01
Wheel stands to convert into HLS 3213-11	AS - HLS3213 - 11
Wheel stands to convert into HLS 3213-14	AS - HLS3213 - 14

Herkules AirgoMatic Pro 3513 und AirgoMatic Pro 3513 DUO	Part-no.
Additional grids for the front end for AirgoMatic Pro 3513, 2 pieces, incl. support angles + fasteners	3000-1000
Pit frame (grids), zinc coated	3000-1001
Pit frame for floorgrid, front end closed, zinc coated	3000-1002
Pit frame (concrete), zinc coated	3000-1003
Pit frame for concrete, front end closed, zinc coated	3000-1004
Drive over ramps, 2 pieces incl. clamps	3000-1005
Height adjustable support platform, zinc coated	300-484
Stützen für AirgoMatic Pro 3513 DUO	3000-1006
Magnetic rubber block holder	3000-1007
hand valve with CE stop and frame	300-370
Control column, painted, without pneumatics	STS-S5
Pneumatic for control column CE-Stop, including signal	200-483
Hose cover, 1,5 m	300-078
90° corner for hose cover	300-140
Hose extension package 3m for AirgoMatic Pro 3513 DUO, incl. Connector	3000-1008
Hose extension package 5m for AirgoMatic Pro 3513 DUO, incl. Connector	3000-1009
Set for enforced deflation of air-bellow (only in combination with CE-Stop)	3000-0281

HERKULES AIRGOMATIC 3213 UND HERKULES AIRGOMATIC 3213 DUO FOR TRANSMOBILE

Flexible solution for the workshop

- 3.2 tons lifting capacity
- Flexible usage at different workstations



HERKULES TRANSMOBIL FOR AIRGOMATIC

Part-no.	Lifting capacity	Drive	Remote control
HLT 06	3,2 t	24 V	Yes

HERKULES AIRGOMATIC 3213 AND HERKULES AIRGOMATIC 3213 DUO FOR TRANSMOBIL

Part-no.	Lifting capacity	Air supply	Wheel stand (min./max.)	Lifting time	Lowering time	Weight	Installation
HLS 3213-17	3,2 t	8 bar	1600/3500 mm	ca. 25 s*	ca. 30 s*	950 kg	Transmobil (HLT-06)
HLS 3213-DUO-17	3,2 t	8 bar	1600/3500 mm	ca. 25 s*	ca. 30 s*	1070 kg	Transmobil (HLT-06)

* Empty lift

HERKULES HLS 1200 AND HERKULES HLS 1200 DUO FOR TRANSMOBIL

Agile solution even for small workshops

- 2.5 tons lifting capacity
- Flexible usage at different workstations



HERKULES TRANSMOBIL FÜR HLS 1200

Part-no.	Lifting capacity	Drive	Remote control
HLT 03	2,5 t	24 V	Yes

HERKULES HLS 1200 AND HERKULES HLS 1200 DUO FOR TRANSMOBIL

Part-no.	Lifting capacity	Air supply	Wheel stand (min./max.)	Lifting time	Lowering time	Weight	Installation
HLS 1200-17	2,5 t	8 bar	1500/3000 mm	ca. 25 s*	ca. 30 s*	800 kg	Transmobil (HLT-03)
HLS 1200-DUO-17	2,5 t	8 bar	1500/3000 mm	ca. 25 s*	ca. 30 s*	850 kg	Transmobil (HLT-03)

* Empty lift



HERKULES TRANSMOBILE

Better workshop utilization - move the vehicles through tight spaces in the workshop safe and easy including E-cars.

Herkules Transmobile creates new working capacity due to a safer and quicker work routine and drastically reduces the work involved in vehicle transportation around the workshop.

The Herkules Transmobile is a mobile unit, which can safely transport the lifts - with or without vehicles - around the workshop. The Transmobile is operated with a remote control and can be used in any workshop with a level surface, even in the spray booth with grid floor

- Reduces vehicle transportation times
- Easy transportation of electric vehicles without batteries
- Powerful self-drive with no harmful exhaust gases
- Vehicle stays masked during transportation between workstations



How does the Transmobile work?

To Video...

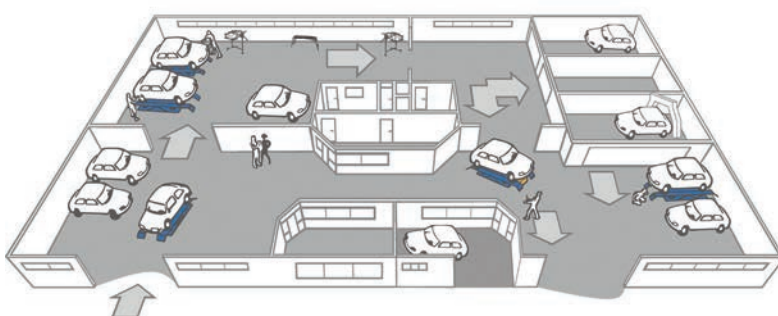

HERKULES TRANSMOBIL

Part.-No.	Lifting capacity	Drive	Remote control
HLT 06 ¹	3,2 t	24 V	Ja
HLT 03 ²	2,5 t	24 V	Ja

1) Suitable for Herkules 3213 AirgoMatic and 3213 Airgomatic Duo
2) Suitable for Herkules HLS 1200 and HLS 1200 Duo

DIMENSIONS

Height (HLT06/HLT03)	456/456 mm
Length (HLT06/HLT03)	2600/2319 mm
Width (HLT06/HLT03)	1488/1450 mm
Wheelbase (HLT06/HLT03)	1919/1583 mm
Weight (HLT06/HLT03)	680/600 kg

HERKULES PAINTER

Safe passanger lift for all kind of works around the vehicle, suitable in the prep area and spray booth

Herkules Painter secure a safe standing and ergonomic working position for the painters when working at higher vehicles like trucks or busses.

The wheels on the lift make it easy to move around in the workshop. Due to its construction, the lift is excellent for small spaces in the prep area as well as in the spray booths.

On the platform of the lift there are several air supplies as well as storage space for the tools, therefore they are always within reach.

- Smooth lifting and lowering
- Excellent for small spaces
- Safe working position
- Smart tool storage on the platform
- Optional with ATEX certification



Painter 01

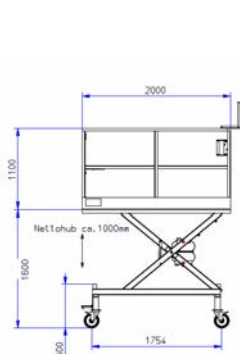

Painter 02 und 05

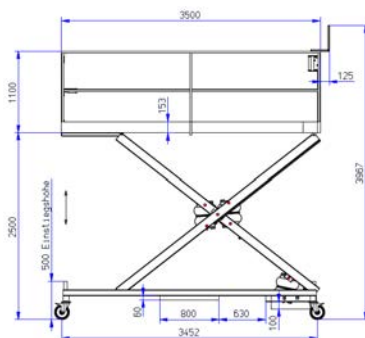

Painter 04

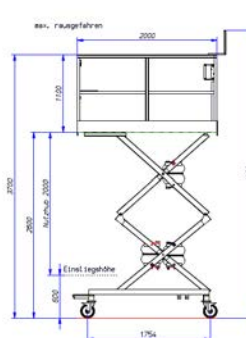

Painter 02

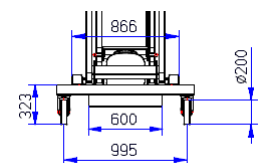

Painter 05

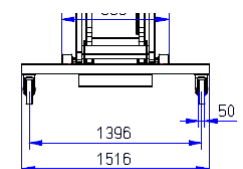

HERKULES PAINTER

Part-no.	Lifting capacity	Air supply	Working height	Platform dimensions	Trolley base
Painter-01	150 kg	8 bar	3,25 m	2000x674 mm	2060x906 mm
Painter-02	150 kg	8 bar	4,00 m	3500x674 mm	3677x1116 mm
Painter-04	150 kg	8 bar	4,00 m	2000x674 mm	2153x1200 mm
Painter-05	250 kg	8 bar	4,00 m	3500x674 mm	3677x1525 mm





WORKSHOP EQUIPMENTS

Increase the productivity - organize the work in the workshop for a safer and more efficient work process

HERKULES LACKY TENDER

The perfect carrying and storage system in the workshop

- Cushioned rack for bulks
- Safety fixation with tension belt
- Continuous extractable bearings



HERKULES LACKY TENDER

Part.-no.	Lenght	Width	Height	Weight
300-297	900 mm	600 mm	1900 mm	41 kg

HERKULES LACKY BUMPER

Safe storage and easy transportation of bulky vehicle parts

- Padded shelves
- Adjustable in many ways
- Easy to rank



HERKULES LACKY BUMPER

Part.-no.	Lenght	Width	Height	Weight
300-399	1200 mm	800 mm	2000 mm	28 kg

HERKULES PAINT STAND

Quick and safe painting- and assembly stand for the workshop

- Wide range of adjustments
- Robust but easy to handle
- Extendable



HERKULES PAINT STAND

Part.-no.
BL-01



DRESTER WHEEL WASHERS

Outstanding cleaning performance with low water consumption
Durable and sustainable solutions

A Drester wheel washer is the perfect piece of equipment for levelling up to a truly professional tire handling. The advantages are obvious - clean wheels, satisfied customers and a cleaner shop. Increase the service level and earn more money!

- Short payback time
- Intelligent heating system
- Gentle & fast cleaning method
- Programmable wash cycles, time controlled heater
- Low water & energy consumption
- Huge time and labours savings
- Improved customer service and increased net savings
- Heat insulating and impact resisting HPE water tank

GRANULE CLEANING METHOD

The Drester granule cleaning method has the best cleaning performance in the shortest time on the market. Two carefully selected kinds of plastic granules with optimal features clean the tire and rim efficiently yet gentle. Most kinds of rims can be cleaned in a Drester wheel washer.

EASY TO USE AND ERGONOMIC

The Drester wheel washers are very easy to use, using mainly symbols in the user interface. The advanced software enables editable settings and customized washing programs. In order to save the operator's back and reduce absences due to back problems, the ergonomic Drester wheel washers can be equipped with a patented, integrated lift or a wheel loading system on the fully automatic machine.



DRESTER GP 24 LE MANS

Advanced and fully automatic wheel washer



- **Payback time from 14 months - washing 8000 wheels/year**
- Load the wheels on a trolley, dock it to the wheel washer and push the start button
- Washes most kinds of alloy and SUV wheels

DRESTER GP 24 LE MANS					WHEEL DIMENSIONS	
Compressed air needed	Air consumption	Air flow	Power supply	Part.no.	Wheel width	135-350 mm (5-14")
8-12 bar (120-174 psi)	400 litre/wash cycle	1000 litre/min. at 7 bar	400V, 3~, 50 Hz, 16 A	GP241-AK ³	Wheel diameter	540-800 mm (22-31")
³⁾ Incl. in delivery: 2 trolleys, 20 kg (44lbs) of DoublePower Granules, Heater, Granule Basket, CleanRinse, Granule Filter					Max Wheel Weight	45 kg (99 lbs)

UNIT DIMENSIONS		WATER CONSUMPTION AND TIME	
Measures (WxDxH)	1620x1100x1550 mm (64x43x61")	Water volume	300 liter
Height, open lid	2360 mm (93")	Water consumption	1 litre/washed wheel
Weight of unit	320 kg (704 lbs) ²	Cleaning time/ wheel ⁴	Adjustable settings from 25-155 sec settings when delivered 25, 50, 75, 100 sec
Weight of trolley	56 kg/trolley	Clean rinse	0.3 litre/wheel

²⁾ without water or DoublePower

⁴⁾ Dry blowing not included

OPTIONS & ACCESSORIES	
Water Cleaning	230350
Trolley/Docking unit	230556
Granule Filter	230508

CONSUMABLES	
Double power granules	230794
Hose Filter	R12038
Basket Filter	R12037
Flocculation Powder	R12076
Detergent BIO 291	BIO-291



DRESTER GP 12 SILVERSTONE

Premium wheel washer with outstanding cleaning performance

- Dynamic flush pipe for fast and efficient cleaning
- **Payback time from 13 months - washing 4000 wheels/year**
- Good for cleaning high polished alloy rims, big tires



DRESTER GP 12 SILVERSTONE

Compressed air needed	Air consumption	Air flow	Power supply	Part.no.
8-12 bar (120-174 psi)	400 litre/wash cycle	1000 litre/min. at 7 bar	400V, 3~, 50 Hz, 16 A	WD12304-AD1

³⁾ Incl. in delivery: 1 rubber mat, 20 kg (44 lbs) of DoublePower Granules, Heater, Granule Basket

WHEEL DIMENSIONS

Wheel width	145-360 mm (6-15")
Wheel diameter	540-860 mm (22-34")
Max Wheel Weight	60 kg (132 lbs)

UNIT DIMENSIONS

Measures (WxDxH) with QuickLift	1081x1201x1489 mm (43x47x59")
	1153x1226x1489 mm (45x48x59")
Weight of unit	240 kg (530 lbs) ²⁾
Weight of QuickLift	26 kg (60 lbs)

²⁾ Without water or DoublePower

WATER CONSUMPTION AND TIME

Water volume	310 liter
Water consumption	1 litre/washed wheel
Cleaning time/ wheel ⁴⁾	Adjustable settings from 25-155 sec settings when delivered 25, 50, 75, 100 sec
Clean rinse	0.3 litre/wheel

⁴⁾ Dry blowing not included

OPTIONS & ACCESSORIES GP10 & GP12

Water Cleaning	230350
Clean Rinse	230357
Quick Lift	230315
Granule Filter	230508

DRESTER GP 10 MONZA

Efficient wheel washer with fantastic cleaning performance

- Fixed flush pipes for rational and efficient cleaning
- **Payback time from 10 months - washing 4000 wheels/year**
- Suitable for standard tires



DRESTER GP 10 MONZA

Compressed air needed	Air consumption	Air flow	Power supply	Part.no.
8-12 bar (120-174 psi)	400 litre/wash cycle	1000 litre/min. at 7 bar	400V, 3~, 50 Hz, 16 A	WD10302-AD1

³⁾ Incl. in delivery: 1 rubber mat, 20 kg (44 lbs) of DoublePower Granules, Heater, Granule Basket

WHEEL DIMENSIONS

Wheel width	145-360 mm (6-15")
Wheel diameter	540-860 mm (22-34")
Max Wheel Weight	60 kg (132 lbs)

UNIT DIMENSIONS

Measures (WxDxH) with QuickLift	1081x1201x1489 mm (43x47x59")
	1153x1226x1489 mm (45x48x59")
Weight of unit	230 kg (510 lbs) ²⁾
Weight of QuickLift	26 kg (60 lbs)

²⁾ Without water or DoublePower

WATER CONSUMPTION AND TIME

Water volume	310 liter
Water consumption	1 litre/washed wheel
Cleaning time/ wheel ⁴⁾	Adjustable settings from 25-155 sec settings when delivered 30, 60, 90, 120 sec
Clean rinse	0.3 litre/wheel

⁴⁾ Dry blowing not included



DRESTER W-450 POWERWASH

Compact and powerful wheel washer for every workshop

- Fixed nozzle flush pipes
- **Payback time from 16 months - washing 2000 wheels/year**
- Cleaning of all kinds of wheels



WHEEL DIMENSIONS

Wheel width	135-305 mm (5-12")
Wheel diameter	560-800 mm (22-31")
Max Wheel Weight	45 kg (99 lbs)

DRESTER W-450 POWERWASH

Compressed air needed	Air consumption	Air flow	Power supply	Part.no.
8-12 bar (120-174 psi)	400 litre/wash cycle	1000 litre/min. at 7 bar	400V, 3~, 50 Hz, 16 A 230V, 3~, 50 or 60 Hz, 32 A	W-450-1AD

³⁾ Incl. in delivery: 1 rubber mat, 20 kg (44 lbs) of DoublePower Granules, Heater, Granule Basket

UNIT DIMENSIONS

Measures (WxDxH)	1140x1005x1450 mm (45x39.5x57")
Weight of unit	220 kg (704 lbs) ²⁾

²⁾ Without water or DoublePower

WATER CONSUMPTION AND TIME

Water volume	210 liter
Water consumption	1 litre/washed wheel
Cleaning time/ wheel ⁴⁾	30, 60, 90, 120 sec

⁴⁾ Dry blowing not included

OPTIONS & ACCESSORIES W-450

Water Cleaning	230812
Clean Rinse	14830
Granule Filter	230508

DRESTER WHEEL WASHERS BY HEDSON

Standard features and equipment

	GP24	GP12	GP10	W-450
Intelligent Heater	●	●	●	
Immersion Heater				●
Granule Filter	●			
Granule Basket	●	●	●	●
Rubber mat		●	●	●
Clean Rinse	●			
Phase recognition	●	●	●	
Auto Start		●	●	
Adjustable washing programs	●	●	●	
Trolleys/Docking Unit	●			
Quicklift (option)		●	●	
Double Power Granules (20 kg, 44 lbs)	●	●	●	●
Prepared for water cleaning	●	●	●	●

DRESTER GP FILTER eQ

Integrated water purification system. Reduces 50% of water consumption and filters up to 97% of all particles. Cost saving and easy to handle.

With the GP Filter eQ filtration unit, it is possible to wash up to 5000 wheels without changing the water while remaining a low water consumption per washed wheel. The efficiency and the work-flow in the shop are improved and the handling is made easier. The Drester GP Filter eQ filtration unit is fully integrated with the software of the Drester wheel washers (the GP and W-750 models), which ensures an easy, user-friendly and reliable cleaning method. The GP Filter eQ water purification method fulfills authority demands for a proper waste water treatment.

Clean wheels with a clean conscience!



ARTICLES IN FILTER VERSIONS

Clean Rinse Retrofit (GP10, 12)	230357
Clean Rinse Kit (W-450)	13630
GP24 Kit eQ	231142
W750 Kit eQ	231213

CONSUMABLES

Floculation Powder, 5kg	R12076
Filter Bags eQ, 15 pcs	231210

ACCESSORIES

Filter Drain Hose Extension 5m eQ	231141
WW Drain Hose Extension 5m eQ	13630
Drain Box eQ	231143
Retrofit / Transfer Kit eQ	231140

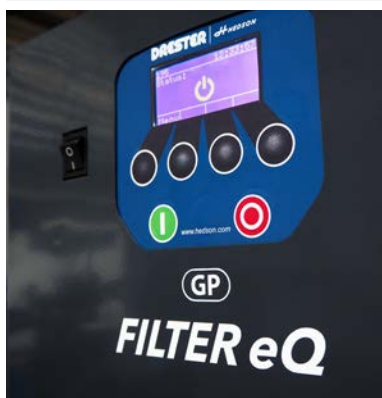

WASTE WATER CLEANING CYCLE

1. Wastewater is pumped from the wheel washer to the filter unit.
2. Inside the filter unit, a flocculating and filtering process separates the waste sludge from the water.
3. Ultimately purified water is directed to a drain.

DIMENSIONS

Height	1884 mm
Width	700 mm
Depth	597 mm
Weight	85 kg

DRESTER GP FILTER eQ

Compressed air needed	Air consumption	Air flow	Power supply	Works with	Part.no.
8-12 bar (120-174 psi)	50 litre/wash cycle	1000 litre/min. at 7 bar	230V, 10 A	Drester GP 10/12/24 and W-750 ¹	231000 / 231000-T

¹⁾ The wheel washer must be equipped with clean rinse to work with the filter unit. Clean Rinse can be retrofitted. BIO-291 detergent can not be used with Hedsons GP Filter eQ. No other detergents may be used in Drester wheel washers.

²⁾ Incl. in delivery: 5 m Drain Hose, 5 m Water Hose, 5 kg Floculation Powder, 15 pcs Filter Bags

WE ARE HERE FOR YOU!

Customer Service

Orders

General inquiries

Technical support

Orders (DE)

General inquiries (DE)

Technical support (DE)

order.a@hedson.com

info@hedson.com

support@hedson.com

bestellung@hedson.com

info.de@hedson.com

service.de@hedson.com

Sales - Germany, Austria, Switzerland and the Netherlands

Jos Keijenberg, Sales leader & NL

Alex Kohl, West

Michael Eismann, Northeast

Hans-Joachim Draband, North

Hans-Juergen Dollmann, DE Southwest & CH

Sven Janssen, Southeast & AT

jos.keijenberg@hedson.com

alex.kohl@hedson.com

michael.eismann@hedson.com

hans-joachim.draband@hedson.com

hans-juergen.dollmann@hedson.com

sven.janssen@hedson.com

Sales - France

Cedric Desmettre

Daniel Jorge

cedric.desmettre@hedson.com

daniel.jorge@hedson.com

Sales - USA & Canada

Mike Bertrand

Shelley Featherstone

Colin Hammacott

mike.bertrand@hedson.com

shelley.featherstone@hedson.com

colin.hammacott@hedson.com

Sales

Niklas Johansson, Sales Leader

Eva Löfgren, Nordics and Baltics

Magnus Lojander, Nordics & UK

Janusz Deneka, Eastern Europe

Carlos Herrera, Spain & Portugal

Juan Alloza, Asia/South Pacific, Latin America

niklas.johansson@hedson.com

eva.lofgren@hedson.com

magnus.lojander@hedson.com

janusz.deneka@hedson.com

carlos.herrera@hedson.com

juan.alloza@hedson.com