

CONSUMABLES

 [back to Section List](#)



Abrasives

1122-1123

Brake Pipes & Accessories

1112-1113

Grease & Fittings

1114-1115

Pressure Sprayers

1134

Adhesives & Sealants

1120-1121

Cable Ties

1109

Hand Cleaning

1139

Rivets

1088-1089

Aerosols

1117-1119

Car Shampoo & Detergents

1136

Heat Shrink Tubing

1104-1105

Shot Blasting

1140

Assortment Boxes

1082-1101

Castor Wheels

1141-1145

Hose Clips

1085-1087

Soldering Accessories

1124

Automotive Cables

1103

Crimp Terminals

1098-1102

Nails & Staples

1124-1125

Tapes

1106-1107

Automotive Fuses & Holders

1096-1097

CVJ Boots & Clamps

1110

Oils

1116

Trim Clips

1126-1133

Battery Terminals

1108

Degreaser

1137

Paint Brushes

1135

Tyre & Wheel Maintenance

1111

Blades

1125

Fasteners & Fixings

1088-1094

Paper Rolls & Wipes

1138-1139

Windscreen Repair Kits

1139



A **AB007RP**
300pc Spring Roll Pin Assortment
Contents (Approximate Quantity): Diameter x Length; Ø2.5 x 25, 2.5 x 30, 3 x 24, 3 x 40, 4 x 25, 4 x 40, 5 x 24, 5 x 40, 6 x 25, 6 x 40, 8 x 25, 8 x 55mm (25 of each)



B **AB006RP**
300pc Spring Roll Pin Assortment - Imperial
Contents (Approximate Quantity): Diameter x Length; Ø3/32" x 1" (x 40), 1/8" x 1" (x40), 1/8" x 1-1/2" (x40), 5/32" x 1" (x30), 5/32" x 1-1/2" (x25), 3/16" x 1" (x25), 3/16" x 1-1/2" (x25), 1/4" x 1" (x25), 1/4" x 1-1/2" (x20), 5/16" x 1" (x20), 5/16" x 2" (x10)



C **AB027CW**
250pc Diesel Injector Copper Washer Assortment
Contents (Approximate Quantity): ID x OD x Thickness; Ø6 x Ø10 x 1 (x20), 10 x 13.5 x 1 (x20), 10 x 20 x 1 (x20), 12 x 16 x 1.5 (x20), 14 x 18 x 1.5 (x20), 16 x 20 x 1.5 (x15), 21 x 25 x 1 (x10), 8 x 11.5 x 1 (x20), 10 x 14 x 1 (x20), 10 x 20 x 2 (x20), 12 x 18 x 1.5 (x20), 14 x 20 x 1.5 (x20), 17 x 21 x 1.5 (x15), 22 x 27 x 1mm (x10)



D **AB020CW**
250pc Copper Sealing Washer Assortment
Contents (Approximate Quantity): ID x OD x Thickness; Ø5 x Ø9 x 1 (x20), 6 x 10 x 1 (x20), 6 x 12 x 1 (x20), 8 x 12 x 1 (x20), 8 x 14 x 1 (x20), 10 x 14 x 1 (x20), 10 x 16 x 1 (x20), 12 x 16 x 1.5 (x15), 12 x 18 x 1.5 (x15), 14 x 18 x 1.5 (x15), 14 x 20 x 1.5 (x15), 16 x 20 x 1.5 (x10), 16 x 22 x 1.5 (x10), 18 x 22 x 1.5 (x10), 18 x 24 x 1.5 (x10), 20 x 26 x 1.5mm (x10)



E **AB014FW**
600pc Fibre Washer Assortment
Contents (Approximate Quantity): ID x OD x Thickness; Ø5 x Ø9 x 1 (x160), 6 x 10 x 1 (x100), 8 x 12 x 1 (x100), 10 x 14 x 1 (x100), 12 x 18 x 1.5 (x60), 14 x 20 x 1.5 (x40), 16 x 22 x 1.5 (x20), 18 x 24 x 1.5mm (x20)



F **ACOR225**
225pc Air Conditioning Rubber O-Ring Assortment
Contents (Approximate Quantity): ID x Thickness; Ø3 x 1, 4 x 1, 4.5 x 2, 5 x 2, 6 x 2, 6 x 2.5, 6 x 3, 7 x 2, 8 x 2mm (20 of each), 9 x 2, 10 x 2, 12 x 3, 13 x 3, 14 x 2.5, 17 x 2.5, 18 x 4, 20 x 2, 22 x 2mm (5 of each)

G **H** **I** **J**

G-J SEE BELOW
In-Line Fuel Filters

	G	H	I	J
Model No:	ILFS10	ILFM10	ILFL5	ILDF5
Inlet/Outlet Diameter:	Ø7mm	Ø8mm	Ø8mm	Ø7mm
Fuel:	Petrol	Petrol	Petrol	Diesel
Pack Quantity:	10	10	5	5

I **J**

A MM



A VS660

Drain Plug Thread Repair Set

Superb for repairing sump, gearbox and differential drain plug threads. Used to tap the damaged thread slightly oversize, then fit a new drain plug and washer (supplied). Set is suitable for the most popular threads used on cars and light commercial vehicles. Supplied in storage case.

Tap Sizes: M13 x 1.5, M15 x 1.5, M17 x 1.5, M20 x 1.5mm

B IMP



B AB011DS

84pc Bonded Seal Assortment - Imperial

Contents (Approximate Quantity): 1/8" (x20), 1/4" (x15), 3/8" (x15), 1/2" (x10), 5/8" (x8), 3/4" (x8), 1" (x8)

C MM



C AB004OR

225pc Rubber O-Ring Assortment

Contents (Approximate Quantity): Ø3.5 x 1.7 (x20), 4.5 x 1.7 (x20), 5 x 1.7 (x20), 6 x 1.7 (x20), 7.5 x 1.7 (x20), 9 x 1.5 (x15), 9.5 x 2.5 (x15), 10.5 x 2.5 (x15), 12.5 x 2.5 (x10), 14 x 2.5 (x10), 15.5 x 2 (x10), 15.5 x 2.5 (x10), 17 x 2.5 (x10), 18.5 x 3.5 (x10), 19 x 2.5 (x10), 21 x 3.5mm (x10)

D MM



D AB010DS

88pc Bonded Seals Assortment

Contents (Approximate Quantity): M18 (x8), M20 (x5), M22 (x5), M24 (x5), M10 (x20), M12 (x15), M14 (x15), M16 (x15)

E BOR407

407pc Rubber O-Ring Assortment Imperial

Manufactured from Buna-N.

Contents (Approximate Quantity):
ID x Thickness; Ø1/8" x 1/16", 3/16" x 1/16", 1/4" x 1/16", 5/16" x 1/16", 3/8" x 1/16", 1/2" x 1/16" (20 of each), 3/8" x 3/32", 7/16" x 3/32", 1/2" x 3/32", 9/16" x 3/32", 5/8" x 3/32", 11/16" x 3/32", 3/4" x 3/32", 13/16" x 3/32", 7/8" x 3/32" (13 of each), 3/4" x 1/8", 13/16" x 1/8", 7/8" x 1/8", 15/16" x 1/8", 1" x 1/8", 1-1/16" x 1/8", 1-1/8" x 1/8", 1-3/16" x 1/8", 1-1/4" x 1/8", 1-5/16" x 1/8", 1-3/8" x 1/8", 1-7/16" x 1/8", 1-1/2" x 1/8", 1-5/8" x 1/8", 1-3/4" x 1/8", 1-7/8" x 1/8", 2" x 1/8" (10 of each)

F BOR419

419pc Rubber O-Ring Assortment

Manufactured from Buna-N.

Contents (Approximate Quantity):
ID x Thickness; Ø18 x 3.5, 20 x 3.5, 22 x 3.5, 23.5 x 3.5, 25 x 3.5, 26.5 x 3.5, 28 x 3.5, 30 x 3.5, 31 x 3.5, 33 x 3.5, 34.5 x 3.5, 36 x 3.5, 38 x 3.5, 41 x 3.5, 44 x 3.5, 47 x 3.5, 50 x 3.5mm (10 of each), 11 x 2.5, 14 x 2.5, 19 x 2.5, 22 x 2.5mm (13 of each), 10 x 2.5, 13 x 2.5, 16 x 2.5, 18 x 2.5, 21 x 2.5mm (14 of each), 5 x 2mm (x18), 3 x 1.5, 4.4 x 2mm (20 of each), 7 x 1.5, 10 x 1.5, 13 x 1.5 (23 of each)

E IMP



F MM



A MM & IMP



A AB001SP

555pc Split Pin Assortment - Small Sizes - Metric & Imperial

Contents (Approximate Quantity): 1/16" x 1" (1.6 x 25.4mm) (x150), 3/32" x 1" (2.4 x 25.4mm) (x150), 3/32" x 1-1/2" (2.4 x 38mm) (x100), 1/8" x 1-1/4" (3.2 x 32mm) (x75), 1/8" x 2" (3.2 x 51mm) (x50), 5/32" x 2-1/2" (4 x 63mm) (x30)

B MM & IMP



B AB003SP

230pc Split Pin Assortment - Large Sizes - Metric & Imperial

Contents (Approximate Quantity): 3/32" x 1-1/2" (2.4 x 38mm) (x100), 5/32" x 2" (4 x 51mm) (x70), 3/16" x 2" (4.8 x 51mm) (x25), 1/4" x 3" (6.3 x 76mm) (x15), 19/64" x 4" (7.5 x 102mm) (x20)

C MM



C AB002RC

150pc R-Clip Assortment

Contents (Approximate Quantity): 2 x 33 (x28), 2 x 40 (x25), 2.4 x 31 (x44), 2.8 x 42 (x25), 3.5 x 45 (x20), 4 x 75mm (x8)

D MM

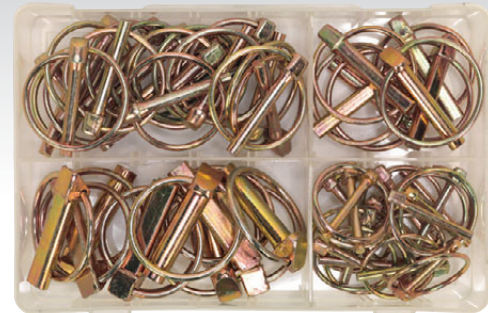

D AB022LP

50pc Linch Pin Assortment

Contents (Approximate Quantity): 4.5 (x16), 6 (x18), 8 (x6), 11mm (x10)

E MM



E AB017CC

200pc Internal/External Circlip Assortment

Contents (Approximate Quantity): External Sizes; 11 (x20), 13 (x15), 16 (x15), 19 (x10), 21 (x10), 22 (x10), 25 (x5), 30 (x5), 35 (x5), 38mm (x5), Internal Sizes; 11 (x20), 13 (x15), 16 (x15), 19 (x10), 21 (x10), 22 (x10), 25 (x5), 30 (x5), 35 (x5), 38mm (x5)

F IMP



F AB019CP

200pc Clevis Pin Assortment - Imperial

Contents (Approximate Quantity): Diameter x Length; Ø3/16" x 5/8" (x35), 3/16" x 7/8" (x35), 1/4" x 1/2" (x30), 1/4" x 1-1/16" (x25), 9/32" x 7/8" (x25), 1/4" x 7/8" (x20), 3/8" x 1-1/4" (x15), 5/16" x 1" (x15)

G IMP



G AB013ER

800pc E-Clip Retainer Assortment - Imperial

Contents (Approximate Quantity): (ID) 1/8" (x150), 5/32" (x150), 3/16" (x100), 7/32" (x80), 1/4" (x80), 5/16" (x50), 3/8" (x50), 7/16" (x50), 1/2" (x50), 5/8" (x40)

H MM



H AB012ER

800pc E-Clip Retainer Assortment

Contents (Approximate Quantity): (ID) 1.7 (x150), 2.75 (x150), 3.5 (x100), 4.5 (x100), 6 (x100), 7 (x80), 13 (x70), 15.5mm (x50)

A MM

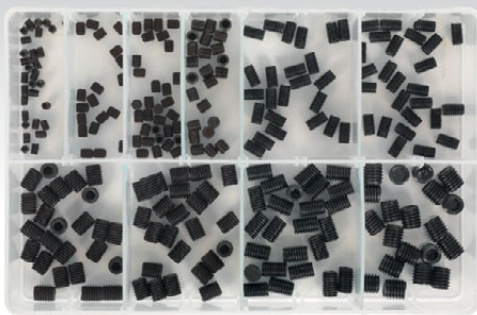

A AB045GS
250pc Grub Screw Assortment DIN 916 - M4-M10

Contents (Approximate Quantity): M4 x 8, M5 x 5, M5 x 10, M6 x 6, M6 x 8, M6 x 10, M8 x 8, M8 x 10, M8 x 12, M10 x 10mm (25 of each)

C MM



C AB042MH
100pc Mini Hose Clip Assortment DIN 1.0338

Contents (Approximate Quantity): Ø7-9, 8-10, 9-11, 10-12, 11-13, 12-14, 13-15, 14-16, 15-17, 16-18mm (10 of each)

E MM



E AB044DE
140pc O-Clip Double Ear Assortment - Zinc Plated
 Manufactured to DIN 1.0338. Zinc plated.

Contents (Approximate Quantity): Ø7-9 (x30), 9-11 (x30), 11-13 (x25), 13-15 (x25), 15-18 (x15), 17-20mm (x15)

F MM



F AB043SE
160pc Stainless Steel O-Clip Single Ear Assortment

Contents (Approximate Quantity): Ø7-8.5 (x30), 8.5-10 (x30), 9.8-11.8 (x25), 11.8-13.8 (x25), 13.2-15.7 (x18), 15.3-18.5 (x18), 17.8-21 (x7), 20.2-22.8mm (x7)

STAINLESS STEEL

B MM



B SHC85AC
85pc Hose Clip Assortment Ø8-57mm

Zinc plated with external pressed threads allowing smooth surface hose contact.

Contents: Band Width 9mm; Ø8-14(000), Ø10-16(M00), Ø13-19(00) (10 of each), Band Width 12mm; Ø16-22(0), Ø16-25(0X), Ø22-32mm(1) (10 of each), Ø25-38(1X), Ø30-40(1XB), Ø32-44(245), Ø35-51(2A), Ø38-57mm(2) (5 of each)

D MM

STAINLESS STEEL



D SHCSS90AC
90pc Stainless Steel Hose Clip Assortment Ø10-57mm

Stainless steel with external pressed threads for smooth surface hose contact.

Contents: Band Width 9mm; Ø10-16(M00), Ø12-22(0), Ø13-19(00), Ø16-27mm(0X) (10 of each), Band Width 12mm; Ø22-32(1), Ø25-38(1X), Ø32-44(245), Ø35-51(2A), Ø38-57mm(2) (10 of each)

G MM



HI-GRIP®



G HCJ85AC
81pc HI-GRIP® Hose Clip Assortment - DIN3017 Ø9.5-55mm

Zinc plated with external pressed threads allowing smooth surface hose contact.

Contents (Approximate Quantity): Band Width 9.5mm; Ø9.5-12(000) (x10), Ø11-16(M00) (x10), Ø13-20mm(00) (x8), Band Width 12mm; Ø14-22(0) (x8), Ø17-25(0X) (x10), Ø22-30(1A) (x10), Ø25-35(1) (x5), Ø30-40(1X) (x5), Ø35-45(1M) (x5), Ø35-50(2A) (x5), Ø40-55mm(2) (x5)



A SEE BELOW

Stainless Steel Hose Clips

SS301A Grade stainless steel hose clips. Manufactured to DIN 3017.

Model No:	Size:	Band Width:	Pack Quantity:
SHCSS000	Ø10-16mm	9.7mm	10
SHCSS00	Ø16-22mm	9.7mm	10
SHCSSM00	Ø13-19mm	9.7mm	10
SHCSS0	Ø16-27mm	9.7mm	10
SHCSS0X	Ø22-32mm	11.7mm	10
SHCSS1A	Ø25-38mm	11.7mm	10
SHCSS1	Ø32-44mm	11.7mm	10
SHCSS1X	Ø35-51mm	11.7mm	10
SHCSSM	Ø38-57mm	11.7mm	10
SHCSS2A	Ø44-64mm	11.7mm	10
SHCSS2	Ø51-70mm	11.7mm	10
SHCSS2X	Ø55-64mm	11.7mm	10
SHCSS3	Ø64-76mm	11.7mm	10
SHCSS3X	Ø70-89mm	11.7mm	5
SHCSS4	Ø80-100mm	11.7mm	5
SHCSS4X	Ø90-110mm	11.7mm	5
SHCSS5	Ø110-130mm	11.7mm	5
SHCSS6	Ø130-150mm	11.7mm	5
SHCSS7	Ø150-170mm	11.7mm	5



D VS063

4pc Flexible Hose Clip Nut Driver Set

150mm Flexible shaft driver with 5, 6 and 7mm sockets. Comfortable, high-grip, textured handle.

Shaft Length:	150mm
Length:	275mm
Sizes:	5, 6, 7mm



B SEE BELOW

Single Ear O-Clips

SS301A Grade stainless steel single ear O-clips. Manufactured to DIN 1.4301.

Model No:	Size:	Pack Quantity:
OCSE78	Ø7-8.5mm	25
OCSE810	Ø8.5-10mm	25
OCSE911	Ø9.8-11.8mm	25
OCSE1113	Ø11.8-13.8mm	25
OCSE1315	Ø13.2-15.7mm	25
OCSE1517	Ø15.3-18.5mm	25
OCSE1720	Ø17.8-21mm	25
OCSE2022	Ø20.2-22.8mm	25



C SEE BELOW

Double Ear O-Clips

Zinc plated double ear O-clips. Manufactured to DIN 1.0338.

Model No:	Size:	Pack Quantity:
OCDE79	Ø7-9mm	25
OCDE911	Ø9-11mm	25
OCDE1113	Ø11-13mm	25
OCDE1315	Ø13-15mm	25
OCDE1518	Ø15-18mm	25
OCDE1720	Ø17-20mm	25
OCDE2023	Ø20-23mm	25



E VS1661

Heavy-Duty Hose Clip Pliers - Clic® Compatible

Heavy-duty spring loaded pliers for fitting and removing Clic® and Clic-R® hose clips. Special jaws allow the change from fit to remove (and back again) simply by turning the pliers over in your hand. PVC dipped handles for improved grip and comfort.



A SEE BELOW

Zinc Plated HI-GRIP® Hose Clips

HI-GRIP® Worm drive hose clips. Zinc plated with external pressed threads allowing for smooth surface hose contact. Manufactured in the UK to DIN 3017.

Model No:	Size:	Band Width:	Pack Quantity:
HCJ000	Ø9.5-12mm	9.5mm	30
HCJM00	Ø11-16mm	9.5mm	30
HCJ00	Ø13-20mm	9.5mm	30
HCJ0	Ø14-22mm	12mm	30
HCJ0X	Ø17-25mm	12mm	20
HCJ1A	Ø22-30mm	12mm	20
HCJ1	Ø25-35mm	12mm	20
HCJ1X	Ø30-40mm	12mm	20
HCJ245	Ø35-45mm	12mm	20
HCJ2A	Ø35-50mm	12mm	20
HCJ2	Ø40-55mm	12mm	20
HCJ2X	Ø45-60mm	12mm	20
HCJ3	Ø55-70mm	12mm	10
HCJ3X	Ø60-80mm	12mm	10
HCJ4	Ø70-90mm	12mm	10
HCJ4X	Ø80-100mm	12mm	10
HCJ5	Ø90-120mm	12mm	10
HCJ6	Ø110-140mm	12mm	10
HCJ7	Ø130-160mm	12mm	10



B SEE BELOW

Zinc Plated Hose Clips

Worm drive hose clips. Zinc plated with external pressed threads allowing for smooth surface hose contact. Manufactured to DIN 3017.

Model No:	Size:	Band Width:	Pack Quantity:
SHC000	Ø8-14mm	9mm	30
SHCM00	Ø10-16mm	9mm	30
SHC00	Ø13-19mm	9mm	30
SHC0	Ø16-22mm	12mm	30
SHC0X	Ø16-25mm	12mm	20
SHC1A	Ø19-29mm	12mm	20
SHC1	Ø22-32mm	12mm	20
SHC1X	Ø25-38mm	12mm	20
SHC245	Ø32-44mm	12mm	20
SHC2A	Ø35-51mm	12mm	20
SHC2	Ø38-57mm	12mm	20
SHC2X	Ø44-64mm	12mm	20
SHC3	Ø51-70mm	12mm	10
SHC3X	Ø64-76mm	12mm	10
SHC4	Ø70-89mm	12mm	10
SHC4X	Ø80-100mm	12mm	10
SHC5	Ø90-110mm	12mm	10
SHC6	Ø120-140mm	12mm	10
SHC7	Ø140-160mm	12mm	10



C SEE BELOW

Zinc Plated HI-GRIP® Hose Clip Assortments

Hi-Grip® worm drive hose clips. Zinc plated with external pressed threads allowing smooth surface hose contact. Manufactured in the UK to DIN 3017.

Model No:	Size:	Band Width:	Pack Quantity:
HCJ85A	Ø9.5-55mm	9.5/12mm	85
HCJ26A	Ø45-160mm	12mm	26



D SEE BELOW

Zinc Plated Hose Clip Assortments

Worm drive hose clips. Zinc plated with external pressed threads allowing for smooth surface hose contact. Manufactured to DIN 3017.

Model No:	Size:	Band Width:	Pack Quantity:
SHCS1	Ø8-29mm	9/12mm	30
SHCS3	Ø8-57mm	9/12mm	85
SHCS2	Ø44-160mm	12mm	26

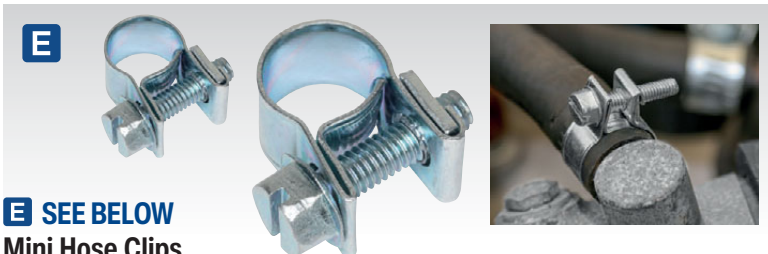

E SEE BELOW

Mini Hose Clips

Zinc plated mini hose clips. Ideal for fuel pipes. Manufactured to DIN 3017.

Model No:	Size:	Pack Quantity:
MHC79	Ø7-9mm	30
MHC810	Ø8-10mm	30
MHC911	Ø9-11mm	30
MHC1012	Ø10-12mm	30
MHC1113	Ø11-13mm	30
MHC1214	Ø12-14mm	30
MHC1315	Ø13-15mm	30
MHC1416	Ø14-16mm	20
MHC1517	Ø15-17mm	20
MHC1618	Ø16-18mm	20



F-G SEE BELOW

Self-Build Hose Clip Sets

Sets include a length of banding and a selection of worm drive tension grips.

Model No:	Band Length:	Band Width:	Worm Drive Tension Grips:
F JC97	3m	8mm	8pc
G JC972	3m	12.7mm	8pc



A SEE BELOW
Regular Threaded Inserts (Rivet Nut)

Zinc plated steel threaded inserts.

Model No:	Thread Size:	Grip Range:	Pack Qty:
TIRM4	M4 x 0.7mm	0.5-2mm	50
TIRM5	M5 x 0.8mm	0.5-2mm	50
TIRM6	M6 x 1mm	0.5-3mm	50
TIRM8	M8 x 1.25mm	0.5-3.5mm	50
TIRM10	M10 x 1.5mm	0.5-3.5mm	50

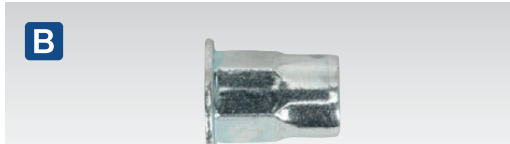

B TIHHM6
M6 Half Hex Threaded Insert (Rivet Nut)

Zinc plated steel threaded inserts.

Thread Size:	Grip Range:	Pack Qty:
M6 x 1mm	0.5-3.5mm	50



C SEE BELOW
Full Hex Threaded Inserts (Rivet Nut) Standard Flange

Zinc plated steel threaded inserts.

Model No:	Thread Size:	Grip Range:	Pack Qty:
TIFHM6	M6 x 1mm	0.5-3.5mm	50
TIFHM8	M8 x 1.25mm	0.5-3.5mm	50



D SEE BELOW
Splined Threaded Inserts (Rivet Nut)

Zinc plated steel threaded inserts.

Model No:	Thread Size:	Grip Range:	Pack Qty:
TISM4	M4 x 0.7mm	0.5-2mm	50
TISM5	M5 x 0.8mm	0.5-2.5mm	50
TISM6	M6 x 1mm	0.5-3mm	50
TISM8	M8 x 1.25mm	0.5-3.5mm	50



G AB073TI
200pc Splined Threaded Insert (Rivet Nut) Assortment M4-M8 - Metric

Contents (Approximate Quantity): M4 x 0.7 (x60), M5 x 0.8 (x40), M6 x 1 (x60), M8 x 1.25mm (x40)



E AK9910
10pc 1/8" Double End Drill Bit Set

High-speed steel double end drill bits. 1/8" Size for pop riveting. Supplied in plastic tube.

Contents: 1/8"(3.2mm) (x10)



F CP314
20V 2Ah Cordless Riveter

Suitable for aluminium, steel and stainless steel rivets from 2.4 to 5mm. Powered by a 20V 2Ah Lithium-ion battery with a pulling force of up to 9000N. Four selectable power settings help preserve battery by only supplying the force required. LED battery level indicator. Four riveting nozzles, 2.4mm, 3.2mm, 4mm and 4.8mm. Supplied in durable plastic storage case with mains charger and 2Ah battery. See page 875 for full specification.



H SEE BELOW
Thread Repair Kits

Creates a stronger internal thread in soft metals. Ideal for repairing damaged or stripped internal threads. Protects tapped threads against wear and damage. Sets include drill bit, thread tap, insert installation and lug breaking tool. Each size supplied with three different lengths of thread insert.

Model No:	Thread Size:	Thread Lengths:	Replacement Thread Inserts:
TRM5	M5 x 0.8mm	3.5, 5, 7mm (5 of each)	TRM5R
TRM6	M6 x 1mm	4, 6, 9mm (5 of each)	TRM6R
TRM8	M8 x 1.25mm	6, 9, 12mm (5 of each)	TRM8R
TRM9	M9 x 1.25mm	7, 14mm (3 of each), 11mm (x4)	TRM9R
TRM10	M10 x 1.5mm	7.5, 15mm (3 of each), 11mm (x4)	TRM10R
TRM12	M12 x 1.75mm	9, 18mm (2 of each), 14mm (x4)	TRM12R
TRM14	M14 x 1.25mm	10, 21mm (1 of each), 16mm (x3)	TRM14R

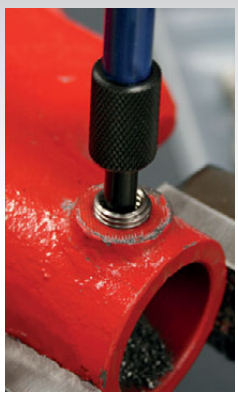

I SEE BELOW
Thread Inserts

Replacement thread inserts.

Model No:	Thread Size:	Thread Lengths:
TRM5R	M5 x 0.8mm	3.5, 5, 7mm (5 of each)
TRM6R	M6 x 1mm	4, 6, 9mm (5 of each)
TRM8R	M8 x 1.25mm	6, 9, 12mm (5 of each)
TRM9R	M9 x 1.25mm	7, 14mm (3 of each), 11mm (x4)
TRM10R	M10 x 1.5mm	7.5, 15mm (3 of each), 11mm (x4)
TRM12R	M12 x 1.75mm	9, 18mm (2 of each), 14mm (x4)
TRM14R	M14 x 1.25mm	10, 21mm (1 of each), 16mm (x3)

A



A SEE BELOW

Aluminium Multi-Grip Rivets

Model No:	Flange Type:	Size (Metric):	Size (Imperial):	Grip Range:	Pack Qty:
RM3210S	Standard	Ø3.2 x 10mm	Ø1/8" x 3/8"	2.5-7mm	200
RM3213S	Standard	Ø3.2 x 13mm	Ø1/8" x 1/2"	9-11mm	200
RM4012S	Standard	Ø4 x 12mm	Ø5/32" x 7/16"	3.5-8.5mm	200
RM4015S	Standard	Ø4 x 15mm	Ø5/32" x 9/16"	5.5-10.5mm	200
RM4813S	Standard	Ø4.8 x 13mm	Ø3/16" x 1/2"	2-8mm	200
RM4819S	Standard	Ø4.8 x 19mm	Ø3/16" x 3/4"	8-14mm	200
RM4827S	Standard	Ø4.8 x 27mm	Ø3/16" x 1-1/16"	17-23mm	200
RM4813L	Large	Ø4.8 x 13mm	Ø3/16" x 1/2"	2-8mm	200
RM4819L	Large	Ø4.8 x 19mm	Ø3/16" x 3/4"	8-14mm	200
RM4827L	Large	Ø4.8 x 27mm	Ø3/16" x 1-1/16"	17-23mm	100

C

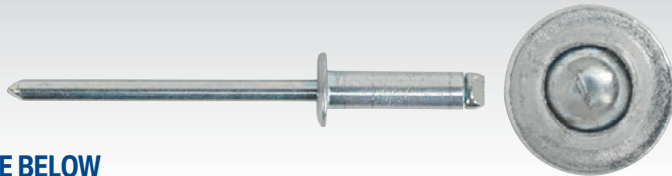

C SEE BELOW

Steel Rivets - Standard Flange

Model No:	Size (Metric):	Size (Imperial):	Grip Range:	Pack Qty:
RS4812	Ø4.8 x 12mm	Ø3/16" x 1/2"	6-8mm	200
RS48615	Ø4.8 x 16.5mm	Ø3/16" x 5/8"	11-13mm	200

F



F SEE BELOW

Load Spreading Aluminium Rivets - Standard Flange

Model No:	Size (Metric):	Size (Imperial):	Grip Range:	Pack Qty:
RB4823	Ø4.8 x 23mm	Ø3/16" x 7/8"	1-9mm	200
RB4827	Ø4.8 x 27mm	Ø3/16" x 1-1/16"	4-12mm	200

H



H AB074BR

200pc Black Anodised Rivet Assortment

Contents (Approximate Quantity): Standard Flange; Ø3.2 x 8 (x25), 4 x 10 (x25), 4.8 x 14mm (x25), Large Flange; Ø3.2 x 10 (x25), 4 x 10 (x25), 4 x 14 (x25), 4.8 x 14 (x25), 4.8 x 18mm (x25)

B



B SEE BELOW

Black Aluminium Rivets

Model No:	Flange Type:	Size (Metric):	Size (Imperial):	Grip Range:	Pack Qty:
RAB3280S	Standard	Ø3.2 x 8mm	Ø1/8" x 5/16"	3.5-5mm	200
RAB4010S	Standard	Ø4 x 10mm	Ø5/32" x 3/8"	5-6.5mm	200
RAB4814S	Standard	Ø4.8 x 14mm	Ø3/16" x 1/2"	8-10mm	200
RAB3210L	Large	Ø3.2 x 10mm	Ø1/8" x 3/8"	5-7mm	200
RAB4010L	Large	Ø4 x 10mm	Ø5/32" x 3/8"	5-6.5mm	200
RAB4014L	Large	Ø4 x 14mm	Ø5/32" x 1/2"	8.5-10.5mm	200
RAB4814L	Large	Ø4.8 x 14mm	Ø3/16" x 1/2"	8-10mm	200
RAB4818L	Large	Ø4.8 x 18mm	Ø3/16" x 3/4"	12-14mm	200

D

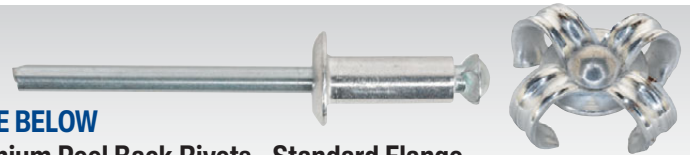

D SEE BELOW

Aluminium Peel Back Rivets - Standard Flange

Model No:	Size (Metric):	Size (Imperial):	Grip Range:	Pack Qty:
RP4812	Ø4.8 x 12mm	Ø3/16" x 7/16"	2-6mm	200
RP4819	Ø4.8 x 19mm	Ø3/16" x 3/4"	8-12mm	200

E

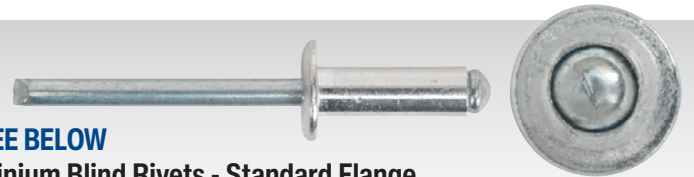

E SEE BELOW

Aluminium Blind Rivets - Standard Flange

Model No:	Size (Metric):	Size (Imperial):	Grip Range:	Pack Qty:
RB6412S	Ø6.4 x 12mm	Ø1/4" x 7/16"	3-6mm	200
RB6418S	Ø6.4 x 18mm	Ø1/4" x 23/32"	10-12mm	200
RB6419S5	Ø6.4 x 19.5mm	Ø1/4" x 3/4"	10-14mm	200

G



G SEE BELOW

Zinc Plated Structural Steel Rivets

Model No:	Size (Metric):	Size (Imperial):	Grip Range:	Pack Qty:
MB6323	Ø6.3 x 23mm	Ø1/4" x 7/8"	2.03-9.53mm	100
MB6332	Ø6.3 x 32mm	Ø1/4" x 1-1/4"	2.03-9.53mm	100

I



I SEE BELOW

Plastic Rivets - Packs of 50

Plastic rivets for Model No's AK499, RT001 and other makes of plastic rivet insertion tools.

Model No:	Size:	Pack Qty:
PR001	Ø6.6 x 17.2mm	50
PR002	Ø6.3 x 25.2mm	50
PR003	Ø5 x 15.8mm	50
PR004	Ø5 x 17.2mm	50

A SEE BELOW (Not Illustrated)

M4-M16 HT Setscrews DIN 933

Model No:	Size:	Pack Qty:
SS410	M4 x 10mm	50
SS416	M4 x 16mm	50
SS420	M4 x 20mm	50
SS425	M4 x 25mm	50
SS512	M5 x 12mm	50
SS516	M5 x 16mm	50
SS520	M5 x 20mm	50
SS525	M5 x 25mm	50
SS530	M5 x 30mm	50
SS540	M5 x 40mm	50
SS550	M5 x 50mm	50
SS612	M6 x 12mm	50
SS616	M6 x 16mm	50
SS620	M6 x 20mm	50
SS625	M6 x 25mm	50
SS630	M6 x 30mm	50
SS635	M6 x 35mm	50
SS640	M6 x 40mm	50
SS650	M6 x 50mm	50
SS660	M6 x 60mm	50
SS675	M6 x 75mm	50
SS816	M8 x 16mm	50
SS820	M8 x 20mm	50
SS825	M8 x 25mm	50
SS830	M8 x 30mm	50
SS835	M8 x 35mm	50
SS840	M8 x 40mm	50
SS850	M8 x 50mm	50
SS860	M8 x 60mm	50
SS870	M8 x 70mm	25
SS875	M8 x 75mm	25
SS8100	M8 x 100mm	25
SS1020	M10 x 20mm	25
SS1025	M10 x 25mm	25
SS1030	M10 x 30mm	25
SS1035	M10 x 35mm	25
SS1040	M10 x 40mm	25
SS1050	M10 x 50mm	25
SS1060	M10 x 60mm	25
SS1070	M10 x 70mm	25
SS1075	M10 x 75mm	25
SS1080	M10 x 80mm	25
SS10100	M10 x 100mm	25
SS1225	M12 x 25mm	25
SS1235	M12 x 35mm	25
SS1240	M12 x 40mm	25
SS1250	M12 x 50mm	25
SS1275	M12 x 75mm	10
SS12100	M12 x 100mm	10
SS1440	M14 x 40mm	10
SS1450	M14 x 50mm	10
SS1470	M14 x 70mm	10
SS1480	M14 x 80mm	10
SS14100	M14 x 100mm	10
SS1650	M16 x 50mm	10
SS1675	M16 x 75mm	10
SS16100	M16 x 100mm	5

H

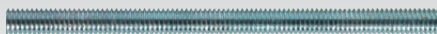

H SEE BELOW

M6-M24 x 1m Threaded Rods DIN 975

Model No:	Size:	Qty:	Model No:	Size:	Qty:
STUD6	M6 x 1m	5	STUD16	M16 x 1m	5
STUD8	M8 x 1m	5	STUD20	M20 x 1m	2
STUD10	M10 x 1m	5	STUD24	M24 x 1m	2
STUD12	M12 x 1m	5			

B



B AB049SNW

444pc High Tensile Setscrew, Nut & Washer Assortment M5

Contents (Approximate Quantity): Setscrews; Diameter x Length; M5 x 16 (x60), M5 x 20 (x40), M5 x 25 (x20), M5 x 40 (x12), M5 x 50mm (x12), Nuts; M5 Steel (x140), Washers; M5 Flat Washer Form A (x160)

D



D AB051SNW

220pc High Tensile Setscrew, Nut & Washer Assortment M8

Contents (Approximate Quantity): Setscrews; Diameter x Length; M8 x 25 (x20), M8 x 40 (x10), M8 x 50 (x10), M8 x 75mm (x10), Nuts; M8 Steel (x50), Washers; M8 Flat Washer Form A (x120)

F



F AB048SS

150pc High Tensile Setscrew Assortment DIN 933

Contents (Approximate Quantity): Diameter x Length; M5 x 25 (x40), M6 x 25 (x40), M8 x 25 (x28), M8 x 40 (x20), M10 x 25 (x8), M10 x 40mm (x14)

I



I AB047UNF

144pc Setscrew Assortment 1/4"-3/8"UNF

Contents (Approximate Quantity): Diameter x Length; 1/4" x 1-1/2" (x50), 1/4" x 1" (x50), 5/16" x 1" (x20), 5/16" x 1-1/2" (x8), 3/8" x 1" (x8), 3/8" x 1-1/2" (x8)

C



C AB050SNW

408pc High Tensile Setscrew, Nut & Washer Assortment M6

Contents (Approximate Quantity): Setscrews; Diameter x Length; M6 x 16 (x50), M6 x 20 (x50), M6 x 25 (x20), M6 x 35 (x12), M6 x 50mm (x12), Nuts; M6 Steel (x144), Washers; M6 Flat Washer Form A (x120)

E



E AB052SNW

150pc High Tensile Setscrew, Nut & Washer Assortment M10

Contents (Approximate Quantity): Setscrews; Diameter x Length; M10 x 25 (x10), M10 x 35 (x10), M10 x 50 (x10), M10 x 75mm (x10), Nuts; M10 Steel (x40), Washers; M10 Flat Washer Form A (x70)

G



G AB029SN

320pc 1/4"-1/2"UNF Steel Nut Assortment

Contents (Approximate Quantity): 1/4"UNF (x120), 5/16"UNF (x120), 3/8"UNF (x50), 1/2"UNF (x30)

J

NEW



J AB030SN

320pc 1/4"-1/2"UNC Steel Nut Assortment

Contents (Approximate Quantity): 1/4"UNC (x120), 5/16"UNC (x120), 3/8"UNC (x50), 1/2"UNC (x30)



A AB028SN
370pc Steel Nut Assortment
DIN 934 - M5-M10

Contents (Approximate Quantity): M5 (x150), M6 (x100), M8 (x80), M10 (x40)



B AB032LN
300pc Nylon Locknut Assortment
DIN 982 - M6-M12

Contents (Approximate Quantity): M6 x 1 (x130), M8 x 1.25 (x100), M10 x 1.5 (x50), M12 x 1.75mm (x20)



C AB031FN
390pc Serrated Flange Nut Assortment
DIN 6923 - M5-M12

Contents (Approximate Quantity): M5 x 0.8 (x120), M6 x 1 (x120), M8 x 1.25 (x120), M10 x 1.5 (x20), M12 x 1.75mm (x10)



D AB046SN
255pc Steel Nut Assortment
DIN 934 - M4-M16

Contents (Approximate Quantity): M4 x 0.7 (x50), M5 x 0.8 (x50), M6 x 1 (x40), M8 x 1.25 (x35), M10 x 1.5 (x30), M12 x 1.75 (x20), M14 x 2 (x15), M16 x 2mm (x15)

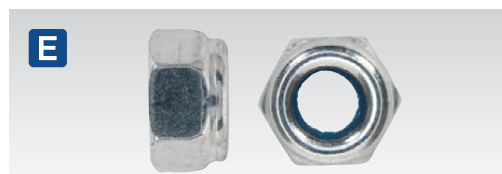

E SEE BELOW
Zinc Plated Nylon Locknuts
DIN 982 - M4-M16

Supplied in resealable bag.

Model No:	Size:	Pitch:	Pack Qty:
NLN4	M4	0.7mm	100
NLN5	M5	0.8mm	100
NLN6	M6	1mm	100
NLN8	M8	1.25mm	100
NLN10	M10	1.5mm	100
NLN12	M12	1.75mm	25
NLN14	M14	2mm	25
NLN16	M16	2mm	25

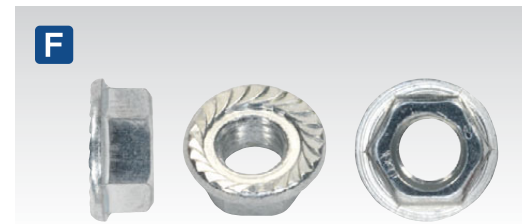

F SEE BELOW
Zinc Plated Serrated Flange Nut
DIN 6923 - M5-M12

Supplied in resealable bag.

Model No:	Size:	Pitch:	Pack Qty:
FN5	M5	0.8mm	100
FN6	M6	1mm	100
FN8	M8	1.25mm	100
FN10	M10	1.5mm	100
FN12	M12	1.75mm	50



G SEE BELOW
Steel Nuts DIN 934 - M3-M24

Supplied in resealable bag.

Model No:	Size:	Pitch:	Pack Qty:
SN3	M3	0.5mm	100
SN4	M4	0.7mm	100
SN5	M5	0.8mm	100
SN6	M6	1mm	100
SN8	M8	1.25mm	100
SN10	M10	1.5mm	100
SN12	M12	1.75mm	25
SN14	M14	2mm	25
SN16	M16	2mm	25
SN20	M20	2.5mm	10
SN24	M24	3mm	5



H AB033LN
255pc Nylon Locknut Assortment
DIN 985 - M4-M16

Contents (Approximate Quantity): M4 x 0.7 (x50), M5 x 0.8 (x50), M6 x 1 (x40), M8 x 1.25 (x35), M10 x 1.5 (x30), M12 x 1.75 (x20), M14 x 2 (x15), M16 x 2mm (x15)



I AB057LW
1000pc Internal Serrated Lock Washer Assortment DIN 6798J - M5-M10

Contents (Approximate Quantity): M5 (x400), M6 (x300), M8 (x200), M10 (x100)

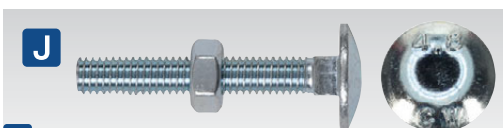

J SEE BELOW
Zinc Plated Coach Bolt & Nuts
DIN 603 - M6-M10

Supplied in resealable bag.

Model No:	Size:	Pitch:	Pack Qty:
CBN640	M6 x 40mm	1mm	100
CBN675	M6 x 75mm	1mm	100
CBN840	M8 x 40mm	1.25mm	50
CBN875	M8 x 75mm	1.25mm	50
CBN1040	M10 x 40mm	1.5mm	50
CBN1075	M10 x 75mm	1.5mm	50

K SDSAB
Sealey Display Stand - Assortment Boxes

Countertop display stand suitable for up to ten consumable assortment boxes, or five trim clip assortment boxes. Can also be used in the workshop as a storage rack. Freestanding or wall mounting.

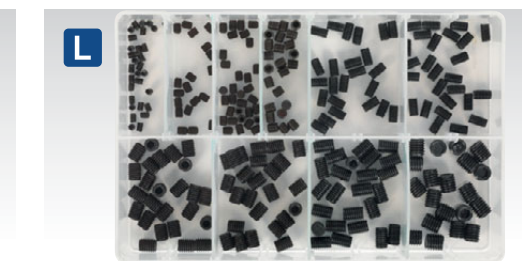
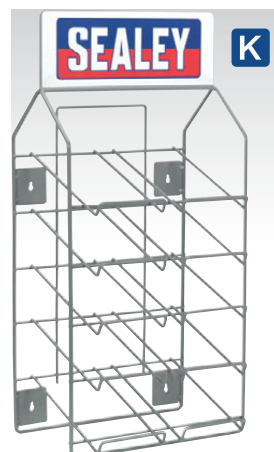

L AB045GS
250pc Grub Screw Assortment
DIN 916 - M4-M10

Contents (Approximate Quantity): M4 x 8, M5 x 5, M5 x 10, M6 x 6, M6 x 8, M6 x 10, M8 x 8, M8 x 10, M8 x 12, M10 x 10mm (25 of each)



A AB055WA
1070pc Form A Flat Washer Assortment
DIN 125 - M5-M16

Contents (Approximate Quantity): M5 x 10 (x300), M6 x 12 (x300), M8 x 17 (x300), M10 x 21 (x100), M12 x 24 (x50), M14 x 28 (x10), M16 x 30mm (x10)



B AB056WC
495pc Form C Flat Washer Assortment
BS 4320 - M6-M24

Contents (Approximate Quantity): M6 x 14 (x170), M8 x 21 (x170), M10 x 24 (x100), M12 x 28 (x30), M14 x 30 (x10), M16 x 34 (x5), M20 x 39 (x5), M24 x 50mm (x5)



C AB059RW
240pc Zinc Plated Repair Washer Assortment - M5-M10

Contents (Approximate Quantity): M5 x 19 (x60), M5 x 25 (x10), M6 x 19 (x60), M6 x 25 (x35), M6 x 38 (x10), M8 x 25 (x35), M8 x 38 (x10), M10 x 30 (x10), M10 x 38mm (x10)



D SEE BELOW
Form A Flat Washers DIN 125 - M4-M20

Manufactured to DIN 125. Supplied in resealable bag.

Model No:	Size:	Pack Qty:
FWA49	M4 x 9mm	100
FWA510	M5 x 10mm	100
FWA612	M6 x 12mm	100
FWA817	M8 x 17mm	100
FWA1021	M10 x 21mm	100
FWA1224	M12 x 24mm	100
FWA1428	M14 x 28mm	50
FWA1630	M16 x 30mm	50
FWA2037	M20 x 37mm	50

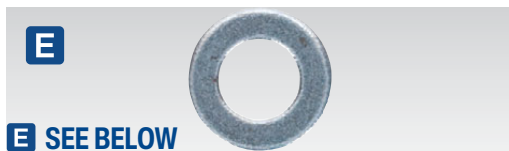

E SEE BELOW
Form C Flat Washers BS 4320 - M5-M24

Manufactured to BS 4320. Supplied in resealable bag.

Model No:	Size:	Pack Qty:
FWC512	M5 x 12.5mm	100
FWC614	M6 x 14mm	100
FWC821	M8 x 21mm	100
FWC1024	M10 x 24mm	100
FWC1228	M12 x 28mm	100
FWC1430	M14 x 30mm	50
FWC1634	M16 x 34mm	50
FWC2039	M20 x 39mm	50
FWC2450	M24 x 50mm	25

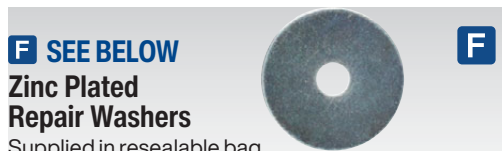

F SEE BELOW
Zinc Plated Repair Washers

Supplied in resealable bag.

Model No:	Size (Metric):	Size (Imp):	Pack Qty:
RW519	M5 x 19mm	3/16" x 3/4"	100
RW525	M5 x 25mm	3/16" x 1"	100
RW619	M6 x 19mm	1/4" x 3/4"	100
RW625	M6 x 25mm	1/4" x 1"	100
RW638	M6 x 38mm	1/4" x 1-1/2"	50
RW825	M8 x 25mm	5/16" x 1"	100
RW838	M8 x 38mm	5/16" x 1-1/2"	50
RW850	M8 x 50mm	5/16" x 2"	50
RW1030	M10 x 30mm	3/8" x 1-1/4"	50
RW1038	M10 x 38mm	3/8" x 1-1/2"	50
RW1050	M10 x 50mm	3/8" x 2"	50



G AB058SW
1010pc Spring Washer Assortment
DIN 127B - M6-M16

Contents (Approximate Quantity): M6 (x400), M8 (x400), M10 (x180), M12 (x10), M14 (x10), M16 (x10)



H AB001SP
555pc Split Pin Assortment - Small Sizes

Contents (Approximate Quantity): 1/16" x 1" (1.6 x 25.4mm) (x150), 3/32" x 1" (2.4 x 25.4mm) (x150), 3/32" x 1-1/2" (2.4 x 38mm) (x100), 1/8" x 1-1/4" (3.2 x 32mm) (x75), 1/8" x 2" (3.2 x 51mm) (x50), 5/32" x 2-1/2" (4 x 63mm) (x30)



I AB003SP
230pc Split Pin Assortment - Large Sizes

Contents (Approximate Quantity): 3/32" x 1-1/12" (2.4 x 38mm) (x100), 5/32" x 2" (4 x 51mm) (x70), 3/16" x 2" (4.8 x 51mm) (x25), 1/4" x 3" (6.3 x 76mm) (x15), 19/64" x 4" (7.5 x 102mm) (x20)



J SEE BELOW
Zinc Plated Spring Washers
DIN 127B - M5-M16

Manufactured to DIN 127B. Supplied in resealable bag.

Model No:	Size:	Pack Qty:
SWM5	M5	100
SWM6	M6	100
SWM8	M8	100
SWM10	M10	50
SWM12	M12	50
SWM14	M14	50
SWM16	M16	50



K SCS271S
50ml High Strength Stud Lock

High strength stud locking adhesive for all types of metal. Rapid fixing time of 15-20 minutes on normal plated, oiled metal surfaces and fixtures. Works on steel, aluminium, stainless steel and zinc.

Fixture Time: 15-20min @ 23°C
Full Cure Time: 24hr @ 23°C



L SEE BELOW
Split Pins

Split pins, zinc plated steel. Supplied in resealable bag.

Model No:	Size (Metric):	Size (Imp):	Pack Qty:
SP100	1.6 x 25mm	1/16" x 1"	100
SP101	2 x 25mm	5/64" x 1"	100
SP102	2.4 x 25mm	3/32" x 1"	100
SP103	2.4 x 38mm	3/32" x 1-1/2"	100
SP104	2.8 x 38mm	7/64" x 1-1/2"	100
SP105	3.2 x 38mm	1/8" x 1-1/2"	100
SP106	3.6 x 38mm	9/64" x 1-1/2"	100
SP107	4 x 41mm	5/32" x 1-5/8"	100
SP108	4 x 51mm	5/32" x 2"	100
SP109	4.8 x 51mm	3/16" x 2"	100

A



A AB065STCP
600pc Zinc Plated Self-Tapping Countersunk Pozi Screw Assortment DIN 7982

Contents (Approximate Quantity): Diameter x Length; 3.5 x 16 (x120), 3.5 x 19 (x120), 3.5 x 25 (x60), 3.5 x 38 (x50), 4.2 x 16 (x60), 4.2 x 19 (x50), 4.2 x 25 (x50), 4.2 x 38 (x30), 4.8 x 19 (x30), 4.8 x 25 (x20), 4.8 x 38mm (x10)

D



D SEE BELOW
Countersunk Pozi Self-Tapping Screws DIN 7982

Supplied in resealable bag.

Model No:	Size:	Pack Qty:
ST3516	3.5 x 16mm	100
ST3525	3.5 x 25mm	100
ST4219	4.2 x 19mm	100
ST4225	4.2 x 25mm	100
ST4238	4.2 x 38mm	100
ST4838	4.8 x 38mm	100
ST6338	6.3 x 38mm	100
ST6351	6.3 x 51mm	100

G



G AB054MS
264pc Machine Screw Assortment Countersunk & Pan Head Pozi - M5-M8

Contents (Approximate Quantity): Diameter x Length; Pan Head; M5 x 20 (x60), M5 x 25 (x60), M6 x 20 (x50), M6 x 25mm (x50), Countersunk; M8 x 20 (x24), M8 x 25mm (x20)

J

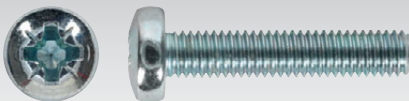

J SEE BELOW
Pan Head Pozi Machine Screws DIN 7985Z

Supplied in resealable bag.

Model No:	Size:	Pack Qty:
MSP520	M5 x 20mm	100
MSP525	M5 x 25mm	50
MSP620	M6 x 20mm	50
MSP625	M6 x 25mm	50

B



B AB060SDS
500pc Self-Drilling Phillips Pan Head Screw Assortment DIN 7504N

Contents (Approximate Quantity): Diameter x Length; 3.5 x 13 (x100), 3.5 x 19 (x100), 3.5 x 25 (x100), 4.2 x 13 (x100), 4.2 x 19 (x40), 4.8 x 25 (x30), 4.8 x 19mm (x30)

E



E SEE BELOW
Zinc Plated Self-Drilling Pan Head Phillips Screws DIN 7504N

Supplied in resealable bag.

Model No:	Size:	Pack Qty:
SDPH4213	M4.2 x 13mm	100
SDPH4219	M4.2 x 19mm	100
SDPH4819	M4.8 x 19mm	100
SDPH4825	M4.8 x 25mm	100

H



H AB064STPP
305pc Self-Tapping Pan Head Pozi Screw Assortment DIN 798CZ

Contents (Approximate Quantity): Diameter x Length; 4.8 x 13 (x80), 4.8 x 19 (x80), 4.8 x 25 (x30), 4.8 x 38 (x25), 5.5 x 19 (x30), 5.5 x 25 (x25), 5.5 x 38 (x15), 6.3 x 25 (x10), 6.3 x 38mm (x10)

K



K SCS2225
50ml Low Strength Thread Lock

A low strength thread lock for all types of metal threaded fasteners. Prevents fasteners loosening due to vibration and seals against leakage, whilst still allowing easy disassembly of treated parts. Fills gaps up to 0.5mm.

Fixture Time:	15min @ 20°C
Full Cure Time:	12hr @ 20°C

C

NEW



C AB425AS
425pc Acme Screw with Captive Washer Assortment - BS 7976/6903

Sheet metal screw (Acme bolt) assortment. Captive washer. Supplied in a partitioned box. See www.sealey.co.uk for contents.

F



F SEE BELOW
Zinc Plated Acme Screws with Captive Washer BS 7976/6903/B M8-M14

Supplied in resealable bag.

Model No:	Size:	Pack Qty:
ASW812	M8 x 1/2"	50
ASW8	M8 x 3/4"	100
ASW101	M10 x 1/2"	100
ASW10	M10 x 3/4"	100
ASW12	M12 x 3/4"	100
ASW121	M12 x 1/2"	50
ASW14	M14 x 3/4"	100
ASW141	M14 x 1/2"	100

I



I AB062STCS
510pc Zinc Plated Self-Tapping Countersunk Pozi Screw Assortment DIN 7982

Contents (Approximate Quantity): Diameter x Length; 3.5 x 16 (x140), 3.5 x 25 (x140), 4.2 x 19 (x130), 4.2 x 25 (x50), 4.2 x 38 (x20), 4.8 x 38mm (x30)

L



L AB063STPH
700pc Self-Tapping Pan Head Pozi Screw Assortment DIN 7981CZ

Contents (Approximate Quantity): Diameter x Length; 3.5 x 13 (x100), 3.5 x 19 (x100), 4.2 x 13 (x100), 4.2 x 19 (x50), 4.2 x 25 (x50), 4.8 x 13 (x50), 4.8 x 19 (x50), 4.8 x 25 (x50), 4.8 x 38 (x50), 5.5 x 19 (x50), 5.5 x 25mm (x50)



A **AB061SDH**
410pc Self-Drilling Hexagon Head Screw Assortment DIN 7504K

Contents (Approximate Quantity): Diameter x Length; 4.2 x 19 (x70), 4.2 x 25 (x80), 4.8 x 13 (x70), 4.8 x 19 (x60), 4.8 x 25 (x60), 5.5 x 25 (x10), 5.5 x 38 (x10), 5.5 x 51 (x10), 6.3 x 25 (x10), 6.3 x 38 (x10), 6.3 x 50mm (x20)



B **AB066STBK**
700pc Self-Tapping Flanged Head Screw Assortment BS 4174

Contents (Approximate Quantity): Diameter x Length; 3.5 x 10 (x160), 3.5 x 19 (x160), 4.2 x 13 (x160), 4.2 x 19 (x60), 4.2 x 25 (x30), 4.8 x 13 (x30), 4.8 x 16 (x30), 4.8 x 19 (x30), 4.8 x 25mm (x40)



C **AB053BH**
108pc Button Head Socket Screw Assortment High Tensile DIN 912 - M5-M10

Contents (Approximate Quantity): Diameter x Length; M5 x 12 (x30), M5 x 16 (x30), M6 x 16 (x10), M8 x 10 (x12), M8 x 20 (x8), M8 x 25 (x8), M10 x 40mm (x10)



D **SEE BELOW**
Zinc Plated Self-Drilling Hex Head Screws DIN 7504K

Supplied in resealable bags.

Model No:	Size:	Pack Qty:
SDHX4213	4.2 x 13mm	100
SDHX4219	4.2 x 19mm	100
SDHX4225	4.2 x 25mm	100
SDHX4813	4.8 x 13mm	100
SDHX4819	4.8 x 19mm	100
SDHX4825	4.8 x 25mm	100
SDHX5525	5.5 x 25mm	100
SDHX5538	5.5 x 38mm	100
SDHX5550	5.5 x 50mm	100
SDHX6325	6.3 x 25mm	100
SDHX6338	6.3 x 38mm	100
SDHX6350	6.3 x 50mm	100

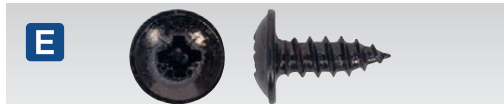

E **SEE BELOW**
Black Pozi Self-Tapping Flanged Head Screws BS 4174

Supplied in resealable bags.

Model No:	Size:	Pack Qty:
BST3510	3.5 x 10mm	100
BST3513	3.5 x 13mm	100
BST3519	3.5 x 19mm	100
BST4213	4.2 x 13mm	100
BST4216	4.2 x 16mm	100
BST4219	4.2 x 19mm	100
BST4225	4.2 x 25mm	100
BST4813	4.8 x 13mm	100
BST4816	4.8 x 16mm	100
BST4819	4.8 x 19mm	100
BST4825	4.8 x 25mm	100



F **ASF103**
#10 x 3/4" Zinc Plated Acme Screw Washer Faced - Pack of 50

Zinc plated BS 6982C acme screw washer faced. Pack of 50. Supplied in resealable bag.

Size:	#10 x 3/4"
Pack Qty:	50

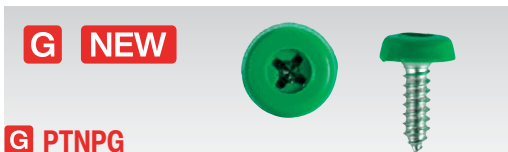

G **NEW**
PTNPG
Green Numberplate Screw - Pack of 50

Green screws match EV number plates. Injection moulded plastic enclosed head. Self-tapping screws securely fasten into place. Supplied in a resealable bag.

Size:	4.8 x 18mm
-------	------------

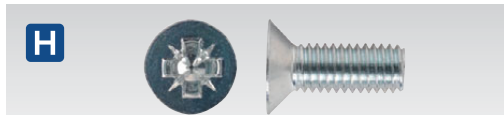

H **SEE BELOW**
Countersunk Pozi Machine Screws DIN 965Z

Supplied in resealable bags.

Model No:	Size:	Pack Qty:
MSC820	M8 x 20mm	50
MSC825	M8 x 25mm	50



I **NEW**
AB195NP
195pc Numberplate Screw Assortment Plastic Enclosed Head

Supplied in a partitioned box.

Quantity:	195, 65 of each colour
Colours:	White, Yellow, Black

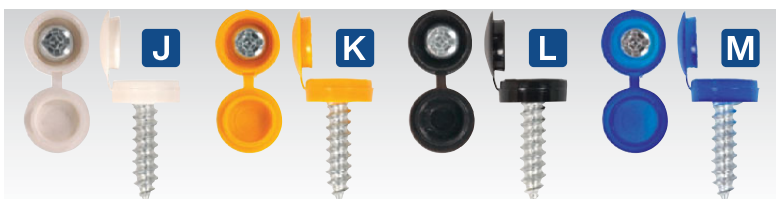

J-M **SEE BELOW**
Numberplate Screws with Flip Cap - 4.2 x 19mm

Self-tapping pan head Pozi numberplate screws with flip caps. Supplied in resealable bag.

Model No:	Size:	Colour:	Pack Qty:
J NPW50	4.2 x 19mm	White	50
K NPY50	4.2 x 19mm	Yellow	50
L NPBK50	4.2 x 19mm	Black	50
M NPBU50	4.2 x 19mm	Blue	50



N-S **SEE BELOW**
Numberplate Screws

Injection moulded plastic enclosed heads. Supplied in resealable bag.

Model No:	Size:	Colour:	Pack Qty:
N PTNP1	4.8 x 18mm	White	50
O PTNP5	4.8 x 24mm	White	50
P PTNP2	4.8 x 18mm	Yellow	50
Q PTNP6	4.8 x 24mm	Yellow	50
R PTNP3	4.8 x 18mm	Black	50
S PTNP7	4.8 x 24mm	Black	50

A-J Speedfit® Pneumatic Couplings

Bodies are produced in an acetal copolymer engineering plastic, especially suitable for pneumatics and corrosion free applications; O-rings are nitrile rubber; collets are produced in acetal copolymer with stainless steel teeth.

C SEE BELOW
Straight Couplings

Model No:	Pipe OD:	Pack Qty:
JGCS6	Ø6mm	5
JGCS8	Ø8mm	5
JGCS10	Ø10mm	5
JGCS12	Ø12mm	5

E SEE BELOW
Equal Tee Couplings

Model No:	Pipe OD:	Pack Qty:
JGCT6	Ø6mm	5
JGCT8	Ø8mm	5
JGCT10	Ø10mm	5
JGCT12	Ø12mm	5

H SEE BELOW
Elbow Couplings

Model No:	Pipe OD:	Pack Qty:
JGCE6	Ø6mm	5
JGCE8	Ø8mm	5
JGCE10	Ø10mm	5
JGCE12	Ø12mm	5

I SEE BELOW
Stem Elbow Couplings

Model No:	Pipe OD:	Pack Qty:
JGCET6	Ø6mm	5
JGCET8	Ø8mm	5
JGCET10	Ø10mm	5
JGCET12	Ø12mm	5

A SEE BELOW
Straight Adaptors

Model No:	Pipe OD:	Thread:	Pack Qty:
JGC614	Ø6mm	1/4" BSP	5
JGC814	Ø8mm	1/4" BSP	5
JGC838	Ø8mm	3/8" BSP	5
JGC1014	Ø10mm	1/4" BSP	5

D AB069JG
32pc Pneumatic Coupling Assortment - Ø6 & Ø8mm

Mix of metric Ø6mm and Ø8mm elbows, straights, stem elbows and equal tees.

Contents (Approximate Quantity): Ø6mm; Straight (x4), Elbow (x4), Equal Tee (x4), Stem Elbow (x4), Ø8mm; Straight (x4), Elbow (x4), Equal Tee (x4), Stem Elbow (x4)

F AB070JG
20pc Pneumatic Coupling Assortment Ø10mm

Mix of metric Ø10mm elbows, straights, stem elbows, equal tees and thread adaptors.

Contents (Approximate Quantity): Straight (x4), Elbow (x4), Equal Tee (x4), Stem Elbow (x4), Thread Adaptor Ø10mm x 1/4" (x4)

J AB071JG
15pc Pneumatic Coupling Assortment Ø12mm

Mix of metric Ø12mm elbows, straights, stem elbows and equal tees.

Contents (Approximate Quantity): Straight (x5), Elbow (x4), Equal Tee (x2), Stem Elbow (x4)

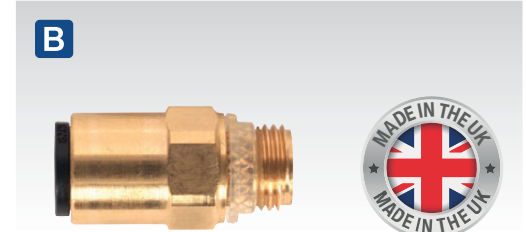
B SEE BELOW
Brass SuperThread Straight Adaptors

Speedfit® SuperThread pneumatic brass couplings, thread adaptor Metric pipe to Imperial thread couplings supplied in sizes 6, 8 and 12mm. Fittings incorporating the SuperThread can be used with BSP (parallel), BSPT (taper), NPTF, PF and PT metal thread forms. The special polyurethane seal feature means no sealant needs to be applied to make the joint airtight.

Model No:	Pipe OD:	Thread:	Pack Qty:
JGBC618	Ø6mm	1/8" BSP	2
JGBC818	Ø8mm	1/8" BSP	2
JGBC814	Ø8mm	1/4" BSP	2
JGBC1238	Ø12mm	3/8" BSP	2

G AB072JG
30pc Pneumatic Coupling Thread Adaptor Assortment Metric & Imperial

Contents (Approximate Quantity): Metric & Imperial Thread Adaptors (OD x Thread); Ø6mm x 1/4" (x5), 8mm x 1/4" (x3), 8mm x 3/8" (x5), 10mm x 1/4" (x5), Brass SuperThread Adaptors (OD x Thread); Ø6mm x 1/8" (x3), 8mm x 1/8" (x3), 8mm x 1/4" (x3), 12mm x 3/8" (x3)

K SEE BELOW
100m Polyethylene Tubing Black

Linear low density polyethylene tubing is suitable for a wide range of temperatures and pressure, has a broad chemical compatibility and is made from non-contaminating materials. Only black tubing should be installed in areas exposed to ultraviolet light.

Model No:	Pipe OD:	Length:
PT6100	Ø6mm	100m
PT8100	Ø8mm	100m
PT10100	Ø10mm	100m
PT12100	Ø12mm	100m



A 20A 30A Standard

A SEE BELOW
Standard Blade Fuse Holders - Packs of 10

Model No:	Rating:
FH20	20A
FH30	30A



B 30A Standard

B FHB30
30A Black Nylon Standard Blade Fuse Holder - Pack of 10

Rating:	30A
---------	-----



AUTOMOTIVE CURRENT TESTERS

See our full range of Automotive Current Testers on page 457.



C 20A 30A Mini

C SEE BELOW
Splashproof MINI Blade Fuse Holders Packs of 10

Model No:	Rating:
FHMSP20	20A
FHMSP30	30A



D 20A 30A Standard

D SEE BELOW
Splashproof Standard Blade Fuse Holders Packs of 10

Model No:	Rating:
FHSP20	20A
FHSP30	30A



E 60A Maxi

E FHMAXSP60
60A Splashproof Maxi Blade Fuse Holder Pack of 2

Rating:	60A
---------	-----



F

F CROCSM
Small Crocodile Clip - Pack of 12 (6 Pairs)
 Maximum current 10A.

Overall Length:	55mm
-----------------	------



G CFT1

Automotive Fuse Checker & Puller

Checks continuity of blade-type automotive fuses, in or out of fuse holder. Green LED indicates fuse is OK. Also simplifies the removal of faulty fuses.

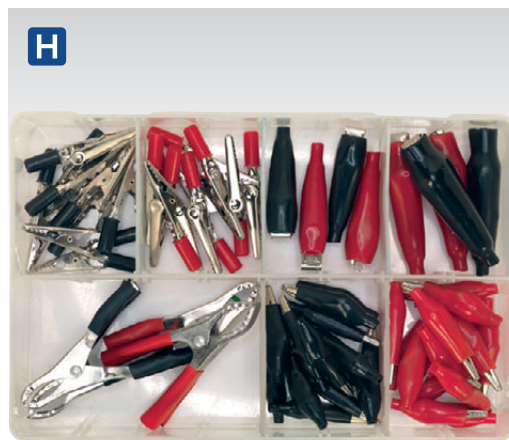

H

H AB023CA
60pc Crocodile Clip Assortment Black & Red

Contents (Approximate Quantity): Non-Insulated; 55 (x20), 70 (x2), 75mm (x2), Insulated; 45 (x16), 55 (x12), 60mm (x8)

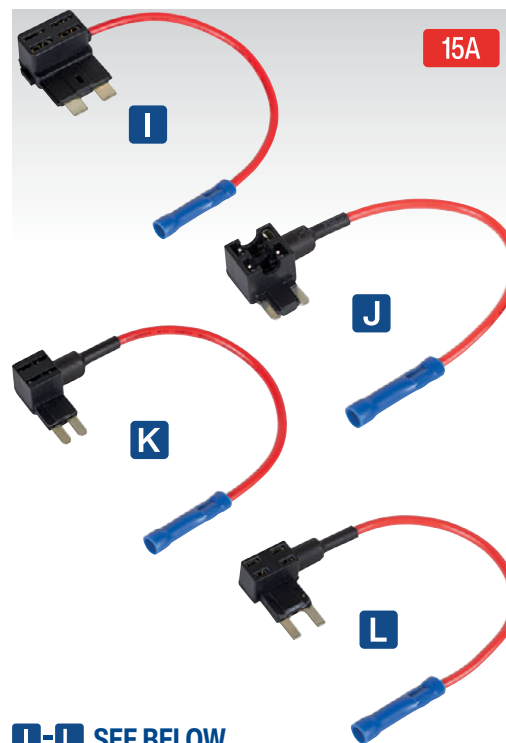

I-L SEE BELOW

15A Accessory Circuit Fuse Holder Links Packs of 2

Range of fuse holders for quick and easy installation of an accessory circuit. Simply remove an existing fuse and insert the fuse holder. Contains two fuse slots, one for the vehicles existing fuse and a second fuse slot for the accessory. Made from nylon and supplied with 150mm of 16 gauge wire. Maximum rated current 15A.

Model No:	Type:	Rating:
I FHLSTA15	Standard	15A
J FHLMIC15	Micro	15A
K FHLMIN15	Mini	15A
L FHLMIC215	Micro II	15A



A SEE BELOW
Automotive MICRO Blade Fuses

Model No:	Rating:	Pack Qty:
MIBF3	3A	50
MIBF5	5A	50
MIBF75	7.5A	50
MIBF10	10A	50
MIBF15	15A	50
MIBF20	20A	50
MIBF25	25A	50
MIBF30	30A	50

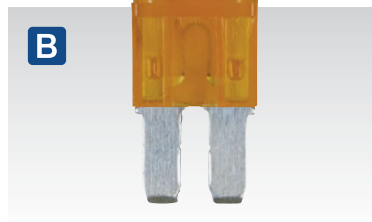

B SEE BELOW
Automotive MICRO II Blade Fuses

Model No:	Rating:	Pack Qty:
M2BF5	5A	50
M2BF75	7.5A	50
M2BF10	10A	50
M2BF15	15A	50
M2BF20	20A	50
M2BF25	25A	50
M2BF30	30A	50



C SEE BELOW
Automotive MINI Blade Fuses

Model No:	Rating:	Pack Qty:
MBF250	2A	50
MBF350	3A	50
MBF450	4A	50
MBF550	5A	50
MBF7550	7.5A	50
MBF1050	10A	50
MBF1550	15A	50
MBF2050	20A	50
MBF2550	25A	50
MBF3050	30A	50

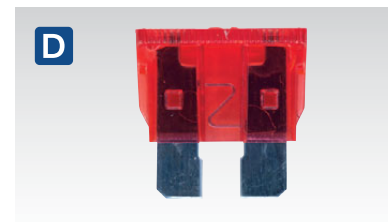

D SEE BELOW
Automotive Standard Blade Fuses

Model No:	Rating:	Pack Qty:
SBF350	3A	50
SBF550	5A	50
SBF7550	7.5A	50
SBF1050	10A	50
SBF1550	15A	50
SBF2050	20A	50
SBF3050	30A	50



E SEE BELOW
Automotive MAXI Blade Fuses

Model No:	Rating:	Pack Qty:
MF2010	20A	10
MF3010	30A	10
MF4010	40A	10
MF5010	50A	10
MF6010	60A	10
MF7010	70A	10
MF8010	80A	10



F BCF36
36pc Automotive MAXI Blade Fuse Assortment

Contents (Approximate Quantity): 20A, 30A, 40A, 50A (6 of each), 60A, 70A, 80A, 100A (3 of each)



G BCF100
100pc Automotive MINI Blade Fuse Assortment

Contents (Approximate Quantity): 2A, 3A, 4A, 5A, 7.5A, 10A, 15A, 20A, 25A, 30A (10 of each)

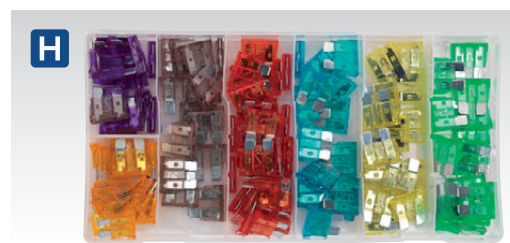

H BCF120
120pc Automotive Standard Blade Fuse Assortment

Contents (Approximate Quantity): 3A, 5A, 7.5A, 15A, 20A, 30A (15 of each), 10A (x30)



I SEE BELOW
Rubber Lined P-Clips

Model No:	Size:	Pack Qty:
PCJ5	Ø5mm	25
PCJ6	Ø6mm	25
PCJ8	Ø8mm	25
PCJ10	Ø10mm	25
PCJ13	Ø12/13mm	25
PCJ16	Ø16mm	25
PCJ21	Ø21mm	25
PCJ25	Ø25mm	25
PCJ29	Ø29mm	25
PCJ32	Ø32mm	25
PCJ35	Ø35mm	25
PCJASS	Ø6, 8, 10, 13, 16, 21mm	60 (10 of each)



J SEE BELOW
10m Spiral Wrap Cable Sleeving

Temperature range of -30°C to +100°C.

Model No:	Type:	Size:
SWS48	Spiral	Ø4-8mm
SWS816	Spiral	Ø8-16mm
SWS1428	Spiral	Ø14-28mm
SWS2244	Spiral	Ø22-44mm



K SEE BELOW
Split Convuluted Cable Sleeving

Temperature range: -40°C to +135°C.

Model No:	Type:	Length:	Size:
CTS0710	Split	10m	Ø7-10mm
CTS0750	Split	50m	Ø7-10mm
CTS07100	Split	100m	Ø7-10mm
CTS07200	Split	200m	Ø7-10mm
CTS1210	Split	10m	Ø12-16mm
CTS1250	Split	50m	Ø12-16mm
CTS12100	Split	100m	Ø12-16mm
CTS12200	Split	200m	Ø12-16mm
CTS1710	Split	10m	Ø17-21mm
CTS2210	Split	10m	Ø22-27mm

Red terminals on this page are suitable for cable size 22-18 AWG

Easy-Entry terminals are designed to help you slide the cable in without fouling.

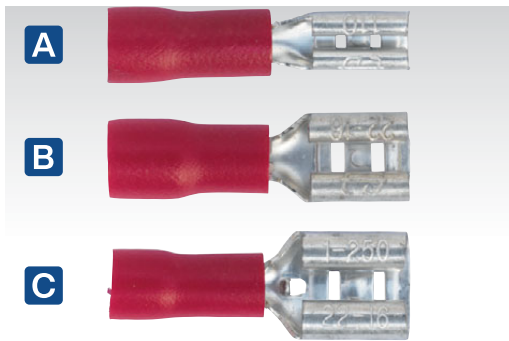

A-C SEE BELOW
Red Push-On Female Terminals

Model No:	Size:	Pack Qty:
A RT19	2.8mm	100
B RT20	4.8mm	100
C RT21	6.3mm	100



H-J SEE BELOW
Red Fully Insulated Female Terminals

Model No:	Size:	Pack Qty:
H RT28	2.8mm	100
I RT30	4.7mm	100
J RT16	6.3mm	100



S RT22
6.3mm Red Push-On Male Terminal

Size:	6.3mm
Pack Qty:	100



T RT17
6.3mm Red Piggy-Back Terminal

Size:	6.3mm
Pack Qty:	100



For our full range of electrical cable, see page 1103.

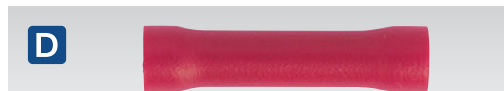

D RT29
Ø3.3mm Red Butt Connector Terminal

Size:	Ø3.3mm
Pack Qty:	100



E RT23
Ø4mm Red Female Socket Terminal

Size:	Ø4mm
Pack Qty:	100



K RT11
Ø4mm Red Male Bullet Terminal

Size:	Ø4mm
Pack Qty:	100

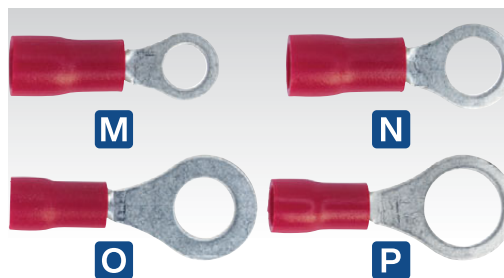

M-P SEE BELOW
Red Easy-Entry Ring Terminals

Model No:	Size:	Pack Qty:
M RT24	Ø4.3mm (4BA)	100
N RT25	Ø5.3mm (2BA)	100
O RT26	Ø6.4mm (1/4")	100
P RT27	Ø8.4mm (5/16")	100



U AB039RT
260pc Red Crimp Terminal Assortment

Contents (Approximate Quantity): Bullet; Ø4mm (x30), Butt Connector; Ø3.3mm (x30), Easy-Entry Fork; Ø3.7mm(4BA) (x10), Ø5.3mm(2BA) (x10), Easy-Entry Pin; 12mm x Ø1.9mm (x10), Easy-Entry Ring; Ø5.3mm(2BA) (x10), Ø8.4mm(5/16") (x10), Female Socket; Ø4mm (x20), Fully Insulated Female; 4.7mm (x20), 6.3mm (x10), Piggy-Back; 6.3mm (x20), Push-On Female; 2.8mm (x20), 4.8mm (x20), 6.3mm (x20), Push-On Male; 6.3mm (x20)



F-G SEE BELOW
Red Easy-Entry Fork Terminals

Model No:	Size:	Pack Qty:
F RT13	Ø3.7mm (4BA)	100
G RT14	Ø5.3mm (2BA)	100



L RT18
12 x Ø1.9mm Red Easy-Entry Pin Terminal

Size:	12 x Ø1.9mm
Pack Qty:	100



Q RT10
18 x 2.3mm Red Blade Terminal

Size:	18 x 2.3mm
Pack Qty:	100

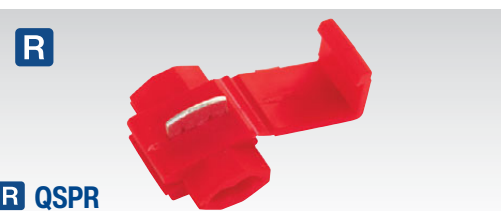

R QSPR
Red Quick Splice Connector

Cable Size:	22-18 AWG
Pack Qty:	100



V AB038MT
200pc Blue, Red & Yellow Crimp Terminal Assortment

Contents (Approximate Quantity): Blue; Bullet; Ø5mm (x10), Butt Connector; Ø4.5mm (x30), Easy-Entry Ring; Ø8.4mm(5/16") (x10), Female Socket; Ø5mm (x10), Fully Insulated Female; 6.3mm (x10), Push-On Female; 6.3mm (x10), Push-On Male; 6.3mm (x10), Red; Bullet; Ø4mm (x10), Butt Connector; Ø3.3mm (x20), Female Socket; Ø4mm (x10), Fully Insulated Female; 6.3mm (x10), Push-On Female; 2.8mm (x10), Push-On Male; 6.3mm (x10), Yellow; Butt Connector; Ø5.5mm (x20), Easy-Entry Ring; Ø6.4mm(1/4") (x10), Ø8.4mm(5/16") (x10)

Blue terminals on this page are suitable for cable size 16-14 AWG

Easy-Entry terminals are designed to help you slide the cable in without fouling.

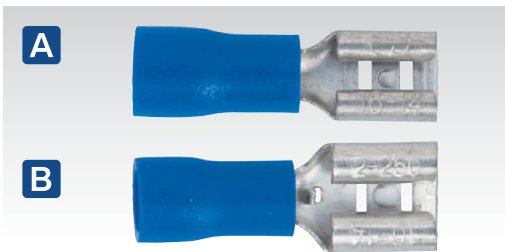

A-B SEE BELOW
Blue Push-On Female Terminals

Model No:	Size:	Pack Qty:
A BT19	4.8mm	100
B BT20	6.3mm	100



E-F SEE BELOW
Blue Fully Insulated Female Terminals

Model No:	Size:	Pack Qty:
E BT15	4.8mm	100
F BT16	6.3mm	100



N BT17
6.3mm Blue Piggy-Back Terminal

Size:	6.3mm
Pack Qty:	100



O BT21
6.3mm Blue Push-On Male Terminal

Size:	6.3mm
Pack Qty:	100



T BT12
Ø4.5mm Blue Butt Connector Terminal

Size:	Ø4.5mm
Pack Qty:	100



U BT22
Ø5mm Blue Female Socket Terminal

Size:	Ø5mm
Pack Qty:	100



C BT11
Ø5mm Blue Male Bullet Terminal

Size:	Ø5mm
Pack Qty:	100

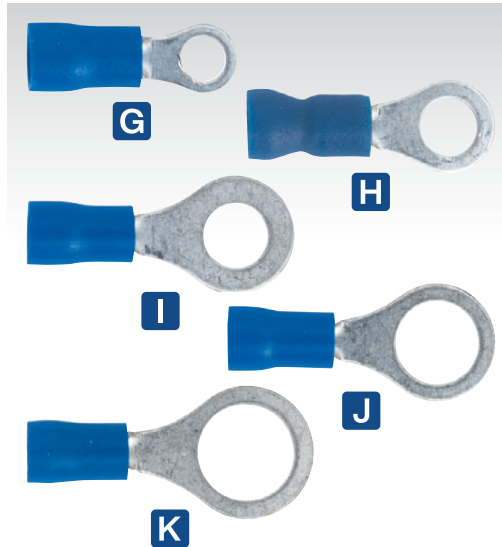

G-K SEE BELOW
Blue Easy-Entry Ring Terminals

Model No:	Size:	Pack Qty:
G BT24	Ø4.3mm (4BA)	100
H BT25	Ø5.3mm (2BA)	100
I BT26	Ø6.4mm (1/4")	100
J BT27	Ø8.4mm (5/16")	100
K BT23	Ø10.5mm (3/8")	100



P-Q SEE BELOW
Blue Easy-Entry Fork Terminals

Model No:	Size:	Pack Qty:
P BT13	Ø3.7mm (4BA)	100
Q BT14	Ø5.3mm (2BA)	100

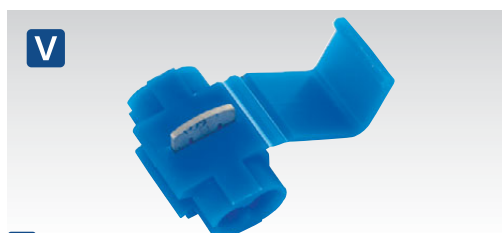

V QSPB
Blue Quick Splice Connector

Cable Size:	16-14 AWG
Pack Qty:	100



D BT18
12 x Ø1.9mm Blue Easy-Entry Pin Terminal

Size:	12 x Ø1.9mm
Pack Qty:	100



L BT10
18 x 2.3mm Blue Blade Terminal

Size:	18 x 2.3mm
Pack Qty:	100



M AB040BT
280pc Blue Crimp Terminal Assortment

Contents (Approximate Quantity): Bullet; Ø5mm (x35), Butt Connector; Ø4.5mm (x40), Easy-Entry Blade; 18mm x 2.3mm (x40), Easy-Entry Fork; Ø3.7mm(4BA) (x10), Ø5.3mm(2BA) (x10), Easy-Entry Pin; 12mm x Ø1.9mm (x10), Easy-Entry Ring; Ø4.3mm(4BA) (x10), Ø6.4mm(1/4") (x10), Ø10.5mm(3/8") (x10), Female Socket; Ø5mm (x35), Fully Insulated Female; 4.8mm (x10), 6.3mm (x10), Piggy-Back; 6.3mm (x20), Push-On Female; 4.8mm (x10), 6.3mm (x10), Push-On Male; 6.3mm (x10)



R-S SEE BELOW
Assortment Boxes with Removable Dividers

Partitioned boxes with hinged lid. Supplied with removable dividers, allowing the boxes to be separated into separate compartments in various configurations. Two snap latches for secure closure. Can be easily stacked for storage.

Model No:	Overall Size (W x D x H):	Dividers:
R ABBOXMED	220 x 150 x 40mm	8
S ABBOXLAR	283 x 173 x 48mm	12

Yellow terminals on this page are suitable for cable size 12-10 AWG

Easy-Entry terminals are designed to help you slide the cable in without fouling.

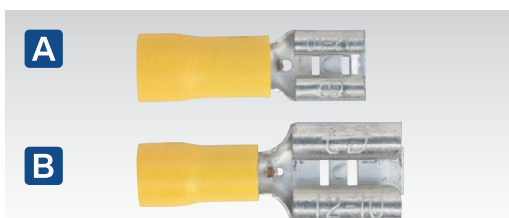

A-B SEE BELOW

Yellow Push-On Female Terminals

Model No:	Size:	Pack Qty:
A YT13	6.3mm	100
B YT14	9.5mm	100



E YT11

6.3mm Yellow Fully Insulated Female Terminal

Size:	6.3mm
Pack Qty:	100

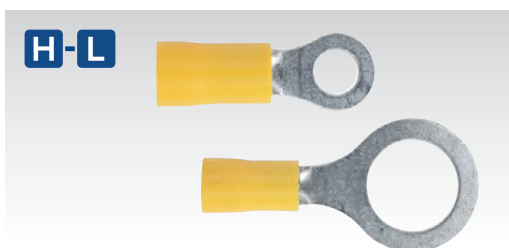

H-L SEE BELOW

Yellow Easy-Entry Ring Terminals

Model No:	Size:	Pack Qty:
H YT18	Ø5.3mm (2BA)	100
I YT19	Ø6.4mm (1/4")	100
J YT20	Ø8.4mm (5/16")	100
K YT16	Ø10.5mm (3/8")	100
L YT17	Ø13mm (1/2")	100

O SEE BELOW

Superseal Connectors

Designed for applications when a waterproof joint is required and is suitable for cable sizes from 0.5mm² to 1.5mm². Kit contains housing, terminals and seals.

Model No:	Ports:	Connector:	Pack Qty:
1 SSC1F	1-Way	Female	5
2 SSC1M	1-Way	Male	5
1+2 SSC1MF	1-Way	Male & Female	1
3 SSC2F	2-Way	Female	5
4 SSC2M	2-Way	Male	5
3+4 SSC2MF	2-Way	Male & Female	1
5 SSC3F	3-Way	Female	5
6 SSC3M	3-Way	Male	5
5+6 SSC3MF	3-Way	Male & Female	1
7 SSC4F	4-Way	Female	3
8 SSC4M	4-Way	Male	3
7+8 SSC4MF	4-Way	Male & Female	1
9 SSC5F	5-Way	Female	3
10 SSC5M	5-Way	Male	3
9+10 SSC5MF	5-Way	Male & Female	1
11 SSC6MF	6-Way	Male & Female	3



C YT21

Ø5mm Yellow Bullet Terminal

Size:	Ø5mm
Pack Qty:	100

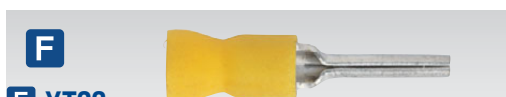

F YT23

14 x Ø2.9mm Yellow Easy-Entry Pin Terminal

Size:	14 x Ø2.9mm
Pack Qty:	100



M YT10

Ø5.5mm Yellow Butt Connector Terminal

Size:	Ø5.5mm
Pack Qty:	100

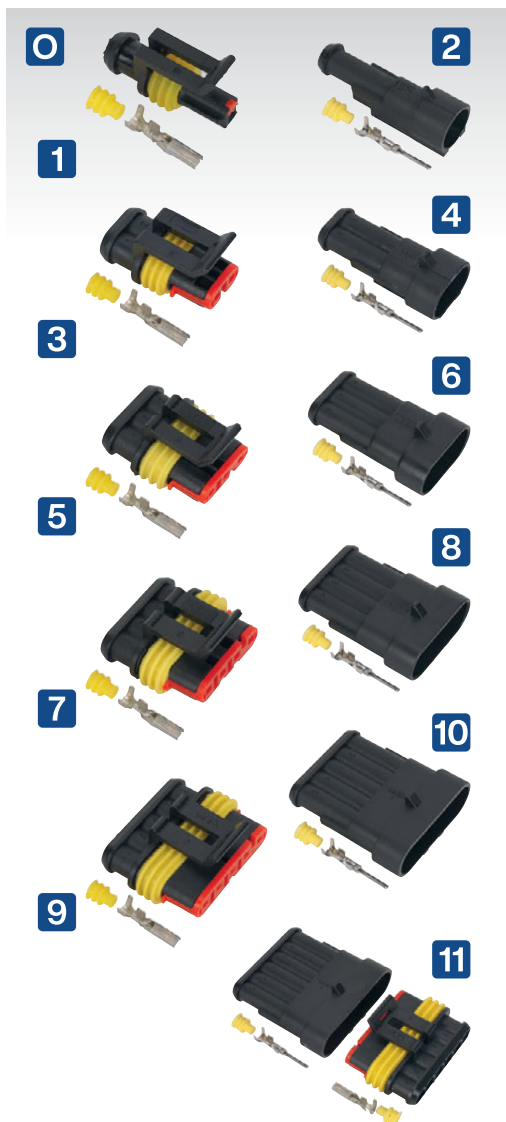

D YT15

6.3mm Yellow Push-On Male Terminal

Size:	6.3mm
Pack Qty:	100



G YT22

Ø5mm Yellow Female Socket Terminal

Size:	Ø5mm
Pack Qty:	100



N AB041YT

140pc Yellow Crimp Terminal Assortment

Contents (Approximate Quantity): Bullet; Ø5mm (x10), Butt Connector; Ø5.5mm (x20), Easy-Entry Pin; 14 x Ø2.9mm (x10), Easy-Entry Ring; Ø5.3mm(2BA) (x10), Ø6.4mm(1/4") (x10), Ø8.4mm(5/16") (x10), Ø10.5mm(3/8") (x10), Ø13mm(1/2") (x10), Female Socket; Ø5mm (x10), Fully Insulated Female; 6.3mm (x10), Push-On Female; 6.3mm (x10), 9.5mm (x10), Push-On Male; 6.3mm (x10)



P SSCSET1

350pc Superseal Male & Female Connector Assortment

Designed for applications when a splashproof joint is required and is suitable for cable sizes from 0.5mm² to 1.5mm². Kit contains male and female housing, terminals and seals.

Contents (Approximate Quantity): 1-Way Female Connector (x6), 1-Way Male Connector (x6), 2-Way Female Connector (x6), 2-Way Male Connector (x6), 3-Way Female Connector (x4), 3-Way Male Connector (x4), 4-Way Female Connector (x4), 4-Way Male Connector (x4), 5-Way Female Connector (x3), 5-Way Male Connector (x3), 6-Way Female Connector (x2), 6-Way Male Connector (x2), Rubber Seal (x100), Female Pin (x100), Male Pin (x100)

A-U SEE BELOW

Heat Shrink Terminals

Fast shrink adhesive lined transparent tubing. Available in colour-coded sizes.

Red 22-18 AWG

A



A SEE BELOW

Ø4.8mm Red Heat Shrink Butt Connector Terminals

Model No:	Type:	Pack Qty:
RTSB50	Ø4.8mm	50
RTSB100	Ø4.8mm	100

D



E



D-E SEE BELOW

Red Heat Shrink Ring Terminals

Model No:	Type:	Pack Qty:
D RTSR2553	Ø5.3mm	25
E RTSR2564	Ø6.4mm	25

J



J RTSPF25

6.4mm Red Female Push-On Heat Shrink Terminal

Size:	6.4mm
Pack Qty:	25

M



M RTSPM25

6.3mm Red Male Push-On Heat Shrink Terminal

Size:	6.3mm
Pack Qty:	25

O



P



Q



R



O-R SEE BELOW

Heat Shrink Solder Butt Connector Terminals

Model No:	Cable Size:	Colour:	Pack Qty:
O RTSSB25	22-18 AWG	Red	25
P BTSSB25	16-14 AWG	Blue	25
Q YTSSB25	12-10 AWG	Yellow	25
R WTSSB25	24-22 AWG	White	25

Blue 16-14 AWG

B



B SEE BELOW

Ø5.8mm Blue Heat Shrink Butt Connector Terminals

Model No:	Type:	Pack Qty:
BTSB50	Ø5.8mm	50
BTSB100	Ø5.8mm	100

F



G



F-G SEE BELOW

Blue Heat Shrink Ring Terminals

Model No:	Type:	Pack Qty:
F BTSR2564	Ø6.4mm	25
G BTSR2584	Ø8.4mm	25

K



K BTSPF25

6.4mm Blue Female Push-On Heat Shrink Terminal

Size:	6.4mm
Pack Qty:	25

N



N BTSPM25

6.3mm Blue Male Push-On Heat Shrink Terminal

Size:	6.3mm
Pack Qty:	25

S



T

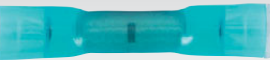

U



S-U SEE BELOW

Cold Seal Butt Connectors

One step termination and environmental protection. Butt connectors require no heat for installation, easy to install along with application flexibility. Connector prevents water entry under permanent pressure or weight.

S

T

U

Model No:	RTCS10	BTCS10	YTCS10
Type:	Ø4.3mm	Ø4.5mm	Ø5.9mm
Cable Size:	26-20 AWG	18-16 AWG	14-12 AWG
Range:	-55° to +150°C	-55° to +150°C	-55° to +150°C
Pack Qty:	10	10	10



Yellow 12-10 AWG

C



C YTSB50

Ø6.8mm Yellow Heat Shrink Butt Connector Terminal

Size:	Ø6.8mm
Pack Qty:	50

H



I



H-I SEE BELOW

Yellow Heat Shrink Ring Terminals

Model No:	Type:	Pack Qty:
H YTSR2564	Ø6.4mm	25
I YTSR2584	Ø8.4mm	25

L



L AB037HT

142pc Adhesive Lined Heat Shrink Terminal Assortment - Blue, Red, Yellow

Contents (Approximate Quantity): Red; Butt Connectors - Ø3.7mm (x20), Push-On Female - 6.4mm (x10), Push-On Male - 6.3mm (x10), Ring - 5.3mm (x7), 6.4mm (x7), Blue; Butt Connectors - Ø5mm (x20), Push-On Female - 6.4mm (x10), Push-On Male - 6.3mm (x10), Ring - 6.4mm (x7), 8.4mm (x7), Yellow; Butt Connectors - Ø6.5mm (x20), Ring - 6.4mm (x7), 8.4mm (x7)

V



V AK2933

Electronic Micro Soldering Torch

For more information, see page 265.



A-D SEE BELOW

Heat Shrink Butt Connector with Crimp & Solder - Packs of 25

Fast heat shrink tubing, allows the user to crimp the terminals for mechanical reliability but also to solder allowing for superior strength and conductivity and then seal for maximum durability.

	A	B	C	D
Model No:	HSSB25B	HSSB25C	HSSB25R	HSSB25Y
Cable Size:	16-14 AWG	26-24 AWG	22-18 AWG	12-10 AWG
Colour:	Blue	Clear	Red	Yellow
Pack Qty:	25	25	25	25



E-F SEE BELOW

13A Plugs

Model No:	Pack Size:
E PL13/320S	Single
F PL13/320	Box of 20



G-H SEE BELOW

13A Heavy-Duty Plugs

Model No:	Pack Size:
G PL/13/3S	Single
H PL/13/3	Box of 10

Available in packs of 10.



230V



I LED360USB.C
5V-1A USB Mains Charger

Input Voltage:	230V
Output:	5V - 1A

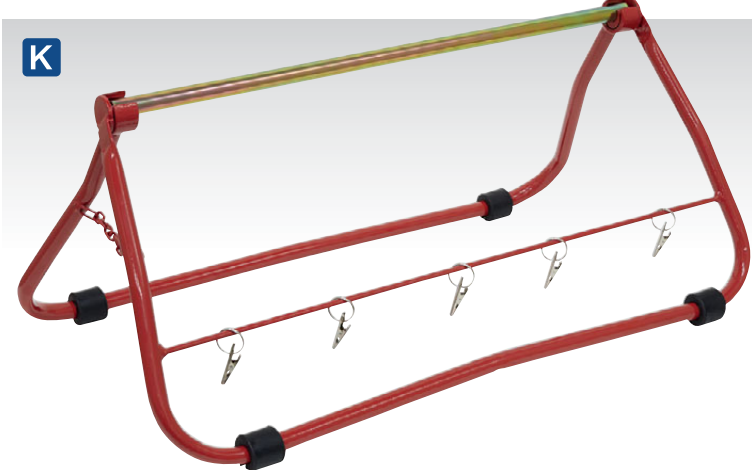

Optional wall brackets.
Order Model No.
CC01WB.

K CC01
Multi Reel Dispenser Cable Carrier Stand

Cable dispenser for reels of wire or electrical cable. Folds flat for easy storage. Robust steel construction will hold multiple reels. Five crocodile clips to secure end of cable to reel.

Capacity:	45kg
Overall Size (W x D x H):	750 x 320 x 350mm
Optional Wall Bracket:	CC01WB



J SMD LED
810 LUMENS

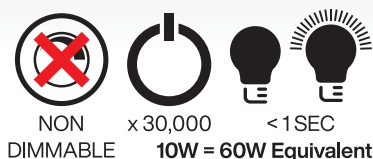

J LED061
9W B22 SMD LED Bulb - 6500K White Light

Economical SMD LED bulb. Ideal as an energy efficient replacement for low efficiency halogen or filament bulbs. Fitted with B22 Bayonet cap, provides a 6500 Kelvin colour temperature known as white light. Not suitable for use with dimmer switches.

Supply:	230V
Power:	9W (90W Incandescent Equivalent)
Lumen Output:	810lm
Fitting:	B22 Bayonet Cap
Colour Temperature:	6500K



A SEE BELOW

Thick Wall Automotive Cable

Thick wall single core PVC insulated automotive cable. Ideal for most popular vehicle applications. Always check the required amperage and mm² cable for your application before fitting. If in doubt consult a qualified automotive electrician.

Temperature Range: -20°C to +80°C					
Model No:	Amps:	Core Type:	Length:	Section:	Core Colour:
AC0507B	5A	Single	7m	0.5mm ²	Black
AC0507G	5A	Single	7m	0.5mm ²	Green
AC0507R	5A	Single	7m	0.5mm ²	Red
AC0806B	8A	Single	6m	0.8mm ²	Black
AC0806G	8A	Single	6m	0.8mm ²	Green
AC0806R	8A	Single	6m	0.8mm ²	Red
AC1704B	17A	Single	4m	2mm ²	Black
AC1704G	17A	Single	4m	2mm ²	Green
AC1704R	17A	Single	4m	2mm ²	Red
AC2725B	27A	Single	2.5m	3mm ²	Black
AC2725G	27A	Single	2.5m	3mm ²	Green
AC2725R	27A	Single	2.5m	3mm ²	Red

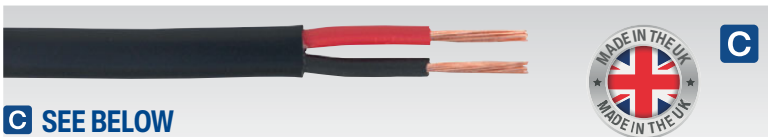

C SEE BELOW

30m Thick Wall Flat Twin Automotive Cable

Flat, thick wall twin core cable supplied on a cardboard reel. Black sheath surrounding black and red cores. Cross sections of 2 x 1mm² (8.75A) and 2 x 2mm² (17.5A) available. RoHS compliant.

Model No:	Amps:	Core Type:	Length:	Section:	Core Colour:
AC1430TWTK	8.75A	Twin	30m	2 x 1mm ²	Red/Black
AC2830TWTK	17.5A	Twin	30m	2 x 2mm ²	Red/Black



E SEE BELOW

10m 170A Automotive Starter Cable

Single core insulated battery/starter cable. Resistant to petrol, lubricating oils and diluted acids. Black or red outer sheath. RoHS compliant.

Model No:	Amps:	Core Type:	Length:	Section:	Colour:
AC25SQBK	170A	Single	10m	25mm ²	Black
AC25SQRE	170A	Single	10m	25mm ²	Red



F SEE BELOW

10m 300A Automotive Starter Cable

Single core insulated battery/starter cable. Black or red outer sheath. Resistant to petrol, lubricating oils and diluted acids. RoHS compliant.

Model No:	Amps:	Core Type:	Length:	Section:	Colour:
AC40SQBK	300A	Single	10m	40mm ²	Black
AC40SQRE	300A	Single	10m	40mm ²	Red

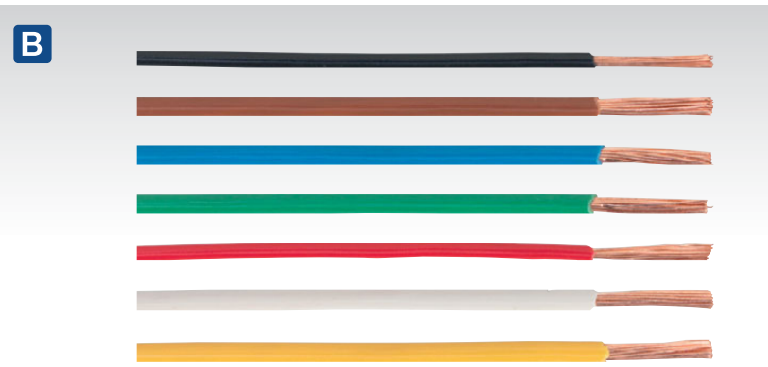

B SEE BELOW

Thin Wall Automotive Cable

Thin wall single core cable supplied on a cardboard reel. 2mm² Cross sections available in black, brown, blue, green, red, white and yellow. 1mm² and 3mm² Cross sections available in black and red. RoHS compliant.

Model No:	Amps:	Core Type:	Length:	Section:	Colour:
AC3220BK	16.5A	Single	50m	1mm ²	Black
AC3220RE	16.5A	Single	50m	1mm ²	Red
AC2830BK	25A	Single	50m	2mm ²	Black
AC2830BN	25A	Single	50m	2mm ²	Brown
AC2830BU	25A	Single	50m	2mm ²	Blue
AC2830GR	25A	Single	50m	2mm ²	Green
AC2830RE	25A	Single	50m	2mm ²	Red
AC2830WH	25A	Single	50m	2mm ²	White
AC2830YE	25A	Single	50m	2mm ²	Yellow
AC4430BK	33A	Single	30m	3mm ²	Black
AC4430RE	33A	Single	30m	3mm ²	Red



D SEE BELOW

30m Thin Wall Flat Twin Automotive Cable

Flat, thin wall twin core cable supplied on a cardboard reel. Black sheath surrounding black and red cores. Cross sections of 2 x 1mm² (8.75A) and 2 x 2mm² (17.5A) available. RoHS compliant.

Model No:	Amps:	Core Type:	Length:	Section:	Core Colour:
AC3220TWTN	8.75A	Twin	30m	2 x 1mm ²	Red/Black
AC2830TWTN	17.5A	Twin	30m	2 x 2mm ²	Red/Black

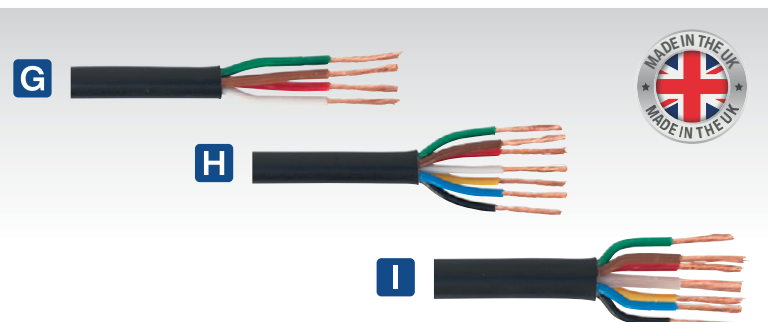

G-I SEE BELOW

30m Multi-Core Thin Wall Automotive Cable

Thin wall multi-core cable supplied on a cardboard reel. Black outer sheath. RoHS compliant.

Model No:	Amps:	Core Type:	Length:	Section:	Core Colour:
G AC24204CTH	14A	4-Core	30m	4 x 0.75mm ²	Mixed
H AC24207CTH	14A	7-Core	30m	7 x 0.75mm ²	Mixed
I AC28307CTH	16.5A 25A	6 + 1 Core	30m	6 x 1mm ² 1 x 2mm ²	Mixed



A HST501B
180pc 50 & 100mm Heat Shrink Tubing Assortment - Black

Length:	50mm
Size (Qty):	Ø3.2 (x60), Ø4.8 (x40), Ø6.4mm (x20)
Length:	100mm
Size (Qty):	Ø3.2 (x30), Ø4.8 (x20), Ø6.4mm (x10)



B HST501BR
180pc 50 & 100mm Heat Shrink Tubing Assortment - Black & Red

Length:	50mm
Size (Qty):	Ø3.2 (x60), Ø4.8 (x40), Ø6.4mm (x20)
Length:	100mm
Size (Qty):	Ø3.2 (x30), Ø4.8 (x20), Ø6.4mm (x10)



C HST501MC
180pc 50 & 100mm Heat Shrink Tubing Assortment - Mixed Colours

Length:	50mm
Size (Qty):	Ø3.2 (x60), Ø4.8 (x40), Ø6.4mm (x20)
Length:	100mm
Size (Qty):	Ø3.2 (x30), Ø4.8 (x20), Ø6.4mm (x10)



D HST100B
95pc 100mm Heat Shrink Tubing Assortment - Black

Length:	100mm
Size (Qty):	Ø3.2 (x30), Ø4.8 (x40), Ø6.4 (x10), Ø9.5 (x10), Ø12.7mm (x5)



E HST100BR
95pc 100mm Heat Shrink Tubing Assortment - Black & Red

Length:	100mm
Size (Qty):	Ø3.2 (x30), Ø4.8 (x40), Ø6.4 (x10), Ø9.5 (x10), Ø12.7mm (x5)



F HST100MC
95pc 100mm Heat Shrink Tubing Assortment - Mixed Colours

Length:	100mm
Size (Qty):	Ø3.2 (x30), Ø4.8 (x40), Ø6.4 (x10), Ø9.5 (x10), Ø12.7mm (x5)



G HST50MC
190pc 50mm Heat Shrink Tubing Assortment - Mixed Colours

Length:	50mm
Size (Qty):	Ø3.2 (x70), Ø4.8 (x70), Ø6.4mm (x50)



H HST200B
100pc 200mm Heat Shrink Tubing - Black

Length:	200mm
Size (Qty):	Ø3.2 (x30), Ø4.8 (x30), Ø6.4 (x20), Ø9.5 (x10), Ø12.7mm (x10)



I HST200BR
100pc 200mm Heat Shrink Tubing Black & Red

Length:	200mm
Size (Qty):	Ø3.2 (x30), Ø4.8 (x30), Ø6.4 (x20), Ø9.5 (x10), Ø12.7mm (x10)



J HST200MC
100pc 200mm Heat Shrink Tubing Mixed Colours

Length:	200mm
Size (Qty):	Ø3.2 (x32), Ø4.8 (x32), Ø6.4 (x20), Ø9.5 (x8), Ø12.7mm (x8)



K AK4042
Micro Butane Heating Torch

Professional micro design featuring piezoelectric ignition. Fitted with anti-ignition cap to prevent accidental operation. Unit produces flame of up to 1300°C and will operate for up to 30 minutes on a single fill. Features adjustable flame control and continuous flame switch. Powered by Butane (lighter fuel).



L HS105
1600W Hot Air Gun 375°C/500°C
For full details, see page 889.



Resealable Bag

A HSTAL72B

72pc 200mm Heat Shrink Dual Wall Adhesive Lined Tubing - Black

Dual wall adhesive provides waterproof and moisture resistant tubing. RoHS compliant. Shrink ratio 3:1 when heated to 90°C.

Contents (Approximate Qty): Ø2.4 (x18), Ø3.2 (x18), Ø4.8 (x12), Ø6.4 (x12), Ø9.5 (x6), Ø12.7mm (x6)



Resealable Bag

B HSTAL72BR

72pc 200mm Heat Shrink Dual Wall Adhesive Lined Tubing - Black & Red

Dual wall adhesive provides waterproof and moisture resistant tubing. RoHS compliant. Shrink ratio 3:1 when heated to 90°C.

Contents (Approximate Qty): Ø2.4 (x18), Ø3.2 (x18), Ø4.8 (x12), Ø6.4 (x12), Ø9.5 (x6), Ø12.7mm (x6)



Resealable Bag

C HSTAL72MC

72pc 200mm Heat Shrink Dual Wall Adhesive Lined Tubing - Mixed Colours

Dual wall adhesive provides waterproof and moisture resistant tubing. RoHS compliant. Shrink ratio 3:1 when heated to 90°C.

Contents (Approximate Qty): Ø2.4 (x18), Ø3.2 (x18), Ø4.8 (x12), Ø6.4 (x12), Ø9.5 (x6), Ø12.7mm (x6)



D HST590MC

590pc 50, 100, 150 & 200mm Heat Shrink Tubing Assortment - Mixed Colours

RoHS compliant heat shrink tubing. Shrink ratio 2:1 when heated to 90°C. Supplied in partitioned box.

Contents (Approximate Quantity): 50mm; Ø1.2 (x100), Ø1.6 (x100), 100mm; Ø2.4 (x100), Ø3.2 (x100), Ø4.8 (x50), Ø6.4 (x50), Ø9.5 (x30), Ø12.7 (x30), 150mm; Ø19.1 (x15), 200mm; Ø25.4mm (x15)



E HSTAL261MC

261pc 100 & 150mm Adhesive Lined Heat Shrink Tubing Assortment - Mixed Colours

RoHS compliant heat shrink adhesive lined tubing. Shrink ratio 3:1 when heated to 100°C. Supplied in partitioned box.

Contents (Approximate Quantity): 100mm; Ø2.4 (x90), Ø3.2 (x60), Ø4.8 (x36), Ø6.4 (x30), Ø9.5 (x18), Ø12.7 (x12), 150mm; Ø15.4 (x6), Ø19.1 (x6), Ø25.4mm (x3)

F SEE BELOW

Heat Shrink Tubing - Black

Model No:	Size:	Tube Length:
HST3215	Ø3.2mm - 1.6mm	15m
HST4812	Ø4.8mm - 2.4mm	12m
HST6412	Ø6.4mm - 3.2mm	12m
HST9508	Ø9.5mm - 4.8mm	8m
HST12708	Ø12.7mm - 6.4mm	8m

G SEE BELOW

Heat Shrink Tubing - Red

Model No:	Size:	Tube Length:
HST3215R	Ø3.2mm - 1.6mm	15m
HST4812R	Ø4.8mm - 2.4mm	12m
HST6412R	Ø6.4mm - 3.2mm	12m
HST9508R	Ø9.5mm - 4.8mm	8m
HST12708R	Ø12.7mm - 6.4mm	8m





A SEE BELOW

19mm x 20m PVC Insulating Tape

Insulating tape, flame retardant to BS EN 60454-2. RoHS compliant.

Length:	20m	
Width:	19mm	
Thickness:	0.15mm	
Model No:	Colour:	Pack Qty:
ITBLU10	Blue	10
ITBLK10	Black	10
ITRED10	Red	10
ITYEL10	Yellow	10
ITWHT10	White	10

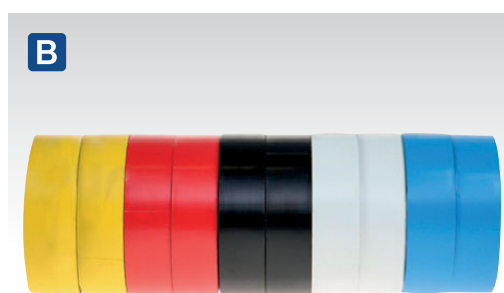

B ITMIX10

19mm x 20m PVC Insulating Tape Mixed Colours

Insulating tape, flame retardant to BS EN 60454-2. RoHS compliant.

Length:	20m	
Width:	19mm	
Thickness:	0.15mm	
Colours:	Yellow, Red, Black, White, Blue (2 of Each)	
Pack Qty:	10	



This product cannot be used with Petrol, Diesel or Brake Fluid

C-E SEE BELOW

5m Silicone Repair Tape

Silicone repair tape used for covering electrical repairs to help create a moisture barrier. Can also be used as a temporary fix on household water pipes and car radiator pipes. Self-fusing and remains flexible. RoHS Compliant.

Tensile Strength:	950psi		
Electrical Insulation:	8000V		
Temperature Range:	-50°C to +260°C		
Model No:	Colour:	Width:	Length:
C ST5C	Clear	25mm	5m
D ST5R	Red	25mm	5m
E ST5B	Black	25mm	5m



F-G SEE BELOW

General-Purpose Masking Tape

Suitable for use up to 60°C.

Model No:	Width:	Length:
F MTG24P	24mm	50m
G MTG48P	48mm	50m



H-I SEE BELOW

Duct Tape

General-purpose duct tape with a gloss finish. Easy to unwind and tear by hand. Reliably strong and adheres instantly.

Model No:	Colour:	Width:	Length:
H DTW	White	50mm	50m
I DTR	Red	50mm	50m

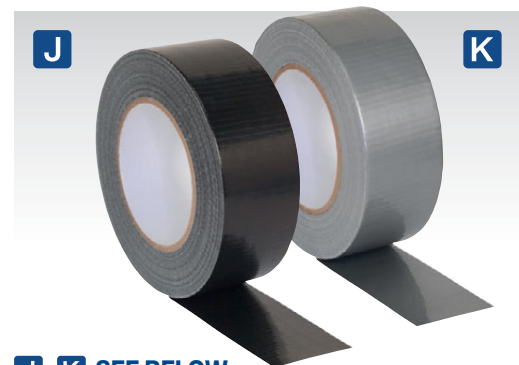

J-K SEE BELOW

Duct Tape

General-purpose duct tape with a gloss finish. Unwinds and tears easily for use, with a very strong initial stick.

Model No:	Colour:	Width:	Length:
J DTB	Black	48mm	50m
K DTS	Silver	48mm	50m



L CT375

Cable Tie Assortment - Pack of 375

Pack of approximately 375 cable ties. Five colours of each size. For our full range of Cable Ties, see page 1109.



M SEE BELOW

Double-Sided Adhesive Foam Tape Green Backing

Double-sided polyethylene closed cell foam tape with green backing. Ideal for bonding irregular surfaces.

Model No:	Width:	Length:
DSTG1210	12mm	10m
DSTG1910	19mm	10m
DSTG2510	25mm	10m
DSTG5010	50mm	10m



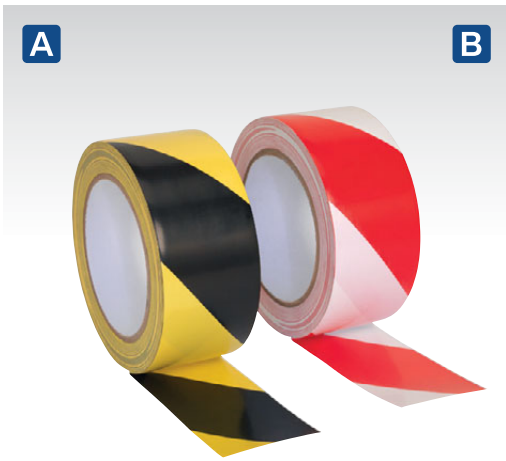

A-B SEE BELOW
50mm x 33m Hazard Warning Tape
 PVC film with adhesive back.

Width:	50mm
Length:	33m
Model No:	Colour:
A HWTBY	Black/Yellow
B HWTRW	Red/White

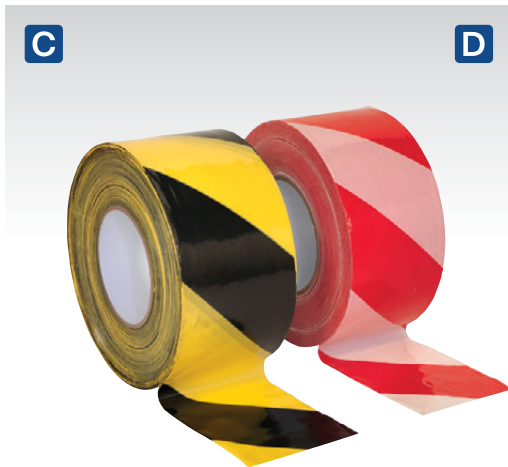

C-D SEE BELOW
80mm x 100m
Non-Adhesive Hazard Warning Barrier Tape
 Non-adhesive PE film.

Width:	80mm
Length:	100m
Model No:	Colour:
C BTBY	Black/Yellow
D BTRW	Red/White



E-F SEE BELOW
50mm x 18m Self-Adhesive Anti-Slip Tape
 Anti-slip tape, for marking out hazards and providing extra grip where necessary.

Width:	50mm
Length:	18m
Model No:	Colour:
E ANTB18	Black
F ANTTY18	Black/Yellow

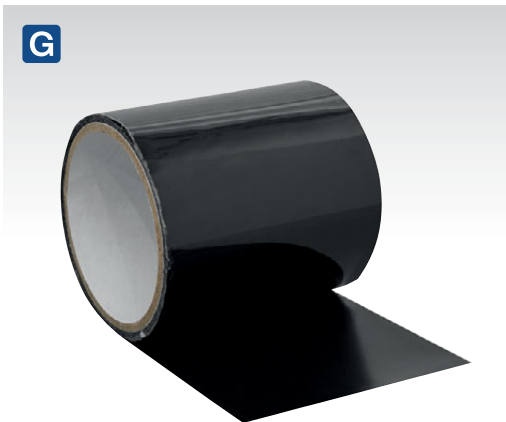

G SRT150
100mm x 1.5m Seal & Repair Tape
 Strong, rubberised, extremely adhesive. Seal and repair tape is waterproof, flexible, heat and cold resistant (-45°C to 90°C). Will adhere to PVC, metal, wood, ceramic, glass, stone and many other surfaces. Designed as a temporary repair.

Width:	100mm
Length:	1.5m



H FT01
19mm x 15m Fleece Tape - Black
 Fleece tape ideal for keeping wire bundles neat and tidy on vehicles or machinery in the workplace. Features of the fleece tape include noise damping, abrasion resistance and bundling strength, all whilst keeping wire bundles flexible.

Width:	19mm
Length:	15m

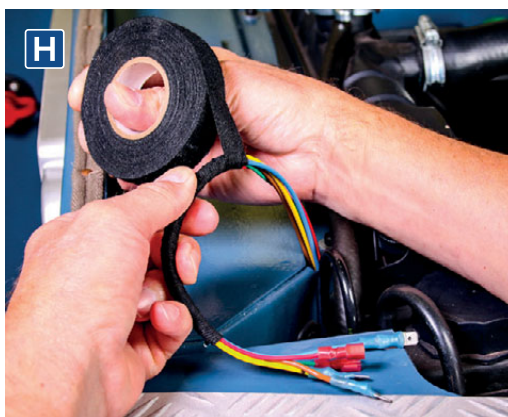

I PTFE1210
PTFE Thread Sealing Tape - Pack of 10
 Polytetrafluoroethylene (PTFE) tape for sealing thread joints. When applied onto a thread it forms an airtight seal. Commonly used with airline system fittings. Supplied in plastic case.

Width:	12mm
Length:	12m
Thickness:	0.075mm
Pack Qty:	10

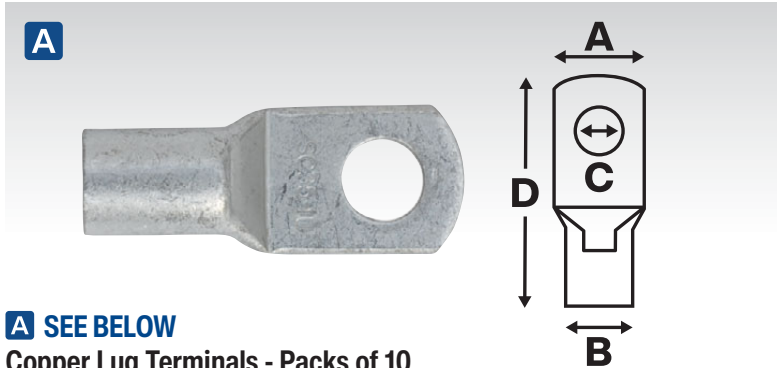

A SEE BELOW

Copper Lug Terminals - Packs of 10

Model No:	Width(A):	Cable Size (B):	Screw Hole Diameter (C):	Length (D):
LT108	12.6mm	10mm ²	Ø8mm	27mm
LT168	12.6mm	16mm ²	Ø8mm	29.5mm
LT256	15mm	25mm ²	Ø6mm	33mm
LT258	15mm	25mm ²	Ø8mm	33mm
LT3510	15mm	35mm ²	Ø10mm	33mm
LT358	15.2mm	35mm ²	Ø8mm	38mm
LT5010	18.5mm	50mm ²	Ø10mm	44.5mm
LT508	18.5mm	50mm ²	Ø8mm	44.5mm
LT7010	21.4mm	70mm ²	Ø10mm	54.2mm
LT7012	21.4mm	70mm ²	Ø12mm	54.2mm

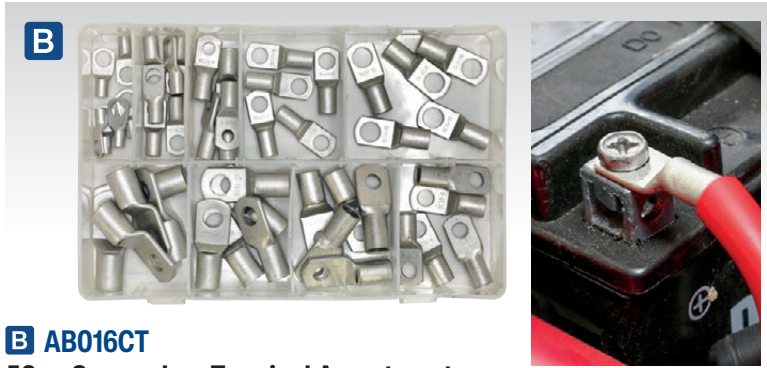

B AB016CT

52pc Copper Lug Terminal Assortment

Contents (Approximate Quantity): Cable Size x Bolt Hole Size; 10mm² x Ø8mm (x6), 16mm² x 8mm (x6), 25mm² x 6mm (x5), 25mm² x 8mm (x5), 35mm² x 8mm (x5), 35mm² x 10mm (x5), 50mm² x 8mm (x5), 50mm² x 10mm (x5), 70mm² x 10mm (x5), 70mm² x 12mm (x5)



C SEE BELOW

12V Light-Duty Battery Terminals

Model No:	Post Type:	Cable Size:	Pack Qty:
BTP1	Positive	25mm ²	10
BTN2	Negative	25mm ²	10



D SEE BELOW

24V Medium-Duty Battery Terminals

Model No:	Post Type:	Cable Size:	Pack Qty:
BTP3	Positive	60mm ²	10
BTN4	Negative	60mm ²	10



F SEE BELOW

24V Heavy-Duty Battery Terminals

Model No:	Post Type:	Cable Size:	Pack Qty:
BTP21	Positive	70mm ²	5
BTN22	Negative	70mm ²	5



G SEE BELOW

24V Battery Terminals Post with Washer & Wing Nut

Model No:	Post Type:	Pack Qty:
BTP23	Positive	5
BTN24	Negative	5

E AK120B

10-120mm² Copper Lug Terminal Crimping Tool

Crimp range 10-120mm². BS Standard type terminal. Made from SCM-40 hard tool steel. Accurate bore diameter and good crimping effect.

Crimp Range: 10-120mm²

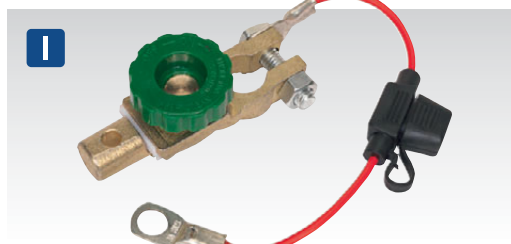

I BTANT1224V

12V-24V Anti-Theft Battery & Fuse Holder

Brass plated finish and RoSH compliant.

Continuous Rating:	125A
Crank Rate:	500A
Voltage:	12V-24V



H SEE BELOW

24V Battery Terminals Post with Washer & Nut

Model No:	Post Type:	Pack Qty:
BTP25	Positive	5
BTN26	Negative	5



J BTQK12

Quick Release Positive-Negative Battery Clamps - Pair

Cable Size:	25mm ²
Positive Post Size:	Ø19mm
Negative Post Size:	Ø17.5mm



A SEE BELOW

Cable Ties - Black

Temperature range -40°C to +85°C.

Model No:	Size:	Pack Qty:
CT10025P200	100 x 2.5mm	200
CT15036P100	150 x 3.4mm	100
CT20048P100	200 x 4.4mm	100
CT30048P100	300 x 4.4mm	100
CT35076P50	350 x 7.6mm	50
CT38048P100	380 x 4.4mm	100
CT45076P50	450 x 7.6mm	50
CT65012P50	650 x 12mm	50

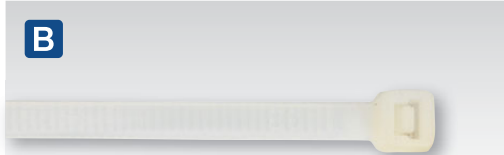

B SEE BELOW

Cable Ties - White

Temperature range -40°C to +85°C.

Model No:	Size:	Pack Qty:
CT10025P200W	100 x 2.5mm	200
CT15036P100W	150 x 3.4mm	100
CT20048P100W	200 x 4.4mm	100
CT30048P100W	300 x 4.4mm	100
CT38048P100W	380 x 4.4mm	100
CT45076P50W	450 x 7.6mm	50



C SEE BELOW

Cable Ties - Black & White Assorted Packs

Temperature range -40°C to +85°C.

Model No:	Size:	Colour:	Pack Qty:
CT600BW	100 x 2.5mm	Black	600
	150 x 3.4mm	&	(100 of each)
	200 x 4.4mm	White	
CT75B	100 x 2.5mm	Black	75
	150 x 3.4mm		(25 of each)
	200 x 4.4mm		
CT75W	100 x 2.5mm	White	75
	150 x 3.4mm		(25 of each)
	200 x 4.4mm		



D CT200

Cable Tie Assortment 100 x 2.5mm Pack of 200

Pack of approximately 200 cable ties. Four colours.

Size:	100 x 2.5mm
Colours:	Blue, Green, Red, Yellow



E CT375

Cable Tie Assortment - Pack of 375

Pack of approximately 375 cable ties. Five colours of each size.

Size:	100 x 2.5, 150 x 3.6, 200 x 4.4mm
Colours:	Black, Green, Red, Yellow, White



F SEE BELOW

Cable Ties - Coloured - Packs of 100

Temperature range -40°C to +85°C.

Model No:	Size:	Colour:	Pk Qty:
CT20048P100Y	200 x 4.4mm	Yellow	100
CT20048P100R	200 x 4.4mm	Red	100
CT20048P100G	200 x 4.4mm	Green	100
CT20048P100B	200 x 4.4mm	Blue	100
CT30048P100S	300 x 4.4mm	Silver	100
CT38048P100S	380 x 4.4mm	Silver	100



G SEE BELOW

Self-Adhesive Cable Tie Mounts - Packs of 100

Model No:	Size:	Colour:	Max. Tie Width:
CTM2020B	20 x 20mm	Black	5mm
CTM2525B	25 x 25mm	Black	6mm
CTM3030B	30 x 30mm	Black	8mm
CTM2020W	20 x 20mm	White	5mm
CTM2525W	25 x 25mm	White	6mm
CTM3030W	30 x 30mm	White	8mm



H AK3254

Cable Tie Fastening Tool

Used for tightening cable ties up to 2.5mm thick and up to 9.5mm wide. Spring loaded handle and spring loaded cutter.

Jaw Height:	2.5mm
Jaw Width:	9.5mm

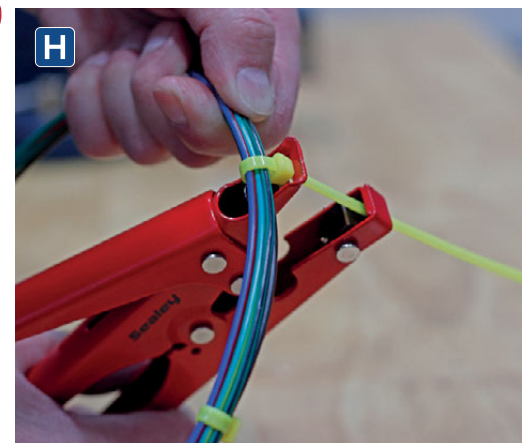

**A SEE BELOW****Duraboot Stretch CVJ Boots**

Made from high quality neoprene that is resistant to grease, water, ozone, abrasion and extremes of temperature. Supplied with fitting kit including clips and grease sachet.

Model No:	Joint Diameter:	Length:
DBC100	Ø80-104mm	90mm
DBC200	Ø73-95mm	106mm
DBC300	Ø86-112mm	119mm
DBC400	Ø80-104mm	112mm
DBC500	Ø70-91mm	84mm
DBC600	Ø76-99mm	92mm
DBC700	Ø74-96mm	99mm
DBC800	Ø60-78mm	104mm

**E CVS18****Ø56-120mm Universal Split CVJ Boot**

No dismantling of joint/shaft required and can be fitted in 20 minutes. Supplied with fitting kit including clips, grease sachet, disposable gloves, glue, cutting guide and fitting instructions.

Joint Diameter:	Ø56-120mm
Shaft Diameter:	Ø19-35mm

**H SEE BELOW****Universal Stretch CVJ Boots**

Supplied with fitting kit including clips, grease sachet and cutting guide. Suitable for vans and light commercial vehicles.

Model No:	Joint Diameter:	Qty:	Shaft Diameter:
CV88	Ø80-120mm	1	Ø28-40mm
CV96	Ø56-116mm	1	Ø19-28mm
CV9612	Ø56-116mm	12	Ø19-28mm

**B-C SEE BELOW****CVJ Boot Ear Clamps - Packs of 25**

Stainless steel, single ear, low profile CVJ boot clamps. Manufactured to DIN 1.4301

Model No:	Diameter:
B CVC01	Ø19-40mm
C CVC02	Ø50-110mm

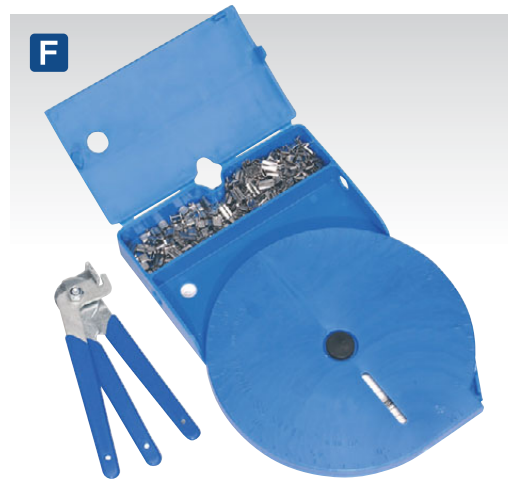
**F BSL102****Universal CVJ Boot Clamp Kit**

Kit includes 56m high quality stainless steel banding with a tensile strength of 420N/mm². The dispenser case also houses 150pc* clamp sets and unique pliers with integrated cutters and band tensioner.

Band Size:	5.5 x 0.4mm
Band Length:	56m
Clamps/Buckles:	150pc*
	*Approximate

**I CV96EU****Ø56-116mm Universal Stretch CVJ Boot EU**

Universal CVJ boot made from high quality neoprene material suitable for use with air operated boot installation tools. Supplied with fitting kit including clips and cutting guide. Suitable for most car and car-derived van applications.

Joint Diameter:	Ø56-116mm
Shaft Diameter:	Ø19-28mm

**D RJC01****Car Ball Joint Dust Covers Pack of 6 Assorted**

Multipurpose ball joint dust covers easily replace split or damaged dust covers on otherwise serviceable ball joints, avoiding MOT test failure. Pack contains six ball joint dust covers supplied in three different sizes (two of each) with retaining O-rings and fitting tool. Covers a wide range of car and small commercial vehicle applications.

Cover Size:	Hole Size:
Small	Ø10mm/25mm
Medium	Ø12mm/36.5mm
Large	Ø15mm/30mm

**G RJC02****Commercial Vehicle Ball Joint Dust Covers - Pack of 3**

Multipurpose ball joint dust covers easily replace split or damaged dust covers on otherwise serviceable ball joints, avoiding MOT test failure. Pack contains three ball joint dust covers supplied with retaining O-rings and fitting tool. Covers a wide range of commercial vehicle applications.

Hole Sizes:	Ø18mm/40.5mm
-------------	--------------

**J SRBK200****Universal Steering Rack Boot Kit**

Universal steering rack boot kit. Inner and outer ends feature trimable sections to facilitate a wide variety of applications. Supplied with plastic securing ties. Contains two steering rack boots.

Inner End Diameter:	Ø 30, 35, 50mm
Outer End Diameter:	Ø 10, 30, 40mm

A SEE BELOW

Wheel Weights Hammer-On Zinc - Steel Wheels

Zinc hammer-on wheel weights. Suitable for most European and Asian vehicles with steel rims. Manufactured to high quality to meet OEM standards.

Model No:	Weight:	Pack Qty:
WWSH05	5g	100
WWSH10	10g	100
WWSH15	15g	100
WWSH20	20g	100
WWSH25	25g	100
WWSH30	30g	100
WWSH35	35g	50
WWSH40	40g	50
WWSH45	45g	50
WWSH50	50g	50

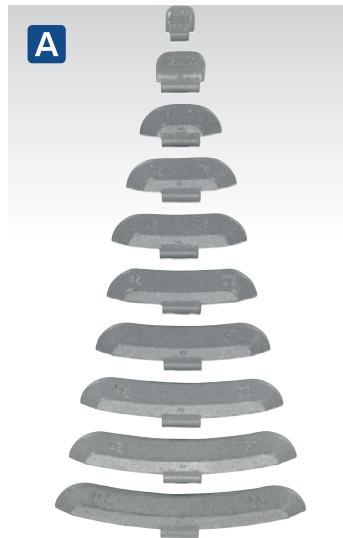

C SEE BELOW

Wheel Weights Hammer-On Plastic Coated Zinc - Alloy Wheels

Plastic coated zinc hammer-on wheel weights. Suitable for most European and Asian vehicles with alloy rims. Manufactured to high quality to meet OEM standards.

Model No:	Weight:	Pack Qty:
WWAH05	5g	100
WWAH10	10g	100
WWAH15	15g	100
WWAH20	20g	100
WWAH25	25g	100
WWAH30	30g	100
WWAH35	35g	50
WWAH40	40g	50
WWAH45	45g	50
WWAH50	50g	50



B

B TST04

Alloy Rim Tyre Valve Installer

Simplifies installation of tyre valves in tubeless wheels. Pulls tyre valve assembly through rim. Shank is notched to accommodate various rim styles. Manufactured from resilient nylon to minimize damage and marking to alloy wheels. Features a valve core removal tool mounted in the base of the handle.

Length: 270mm

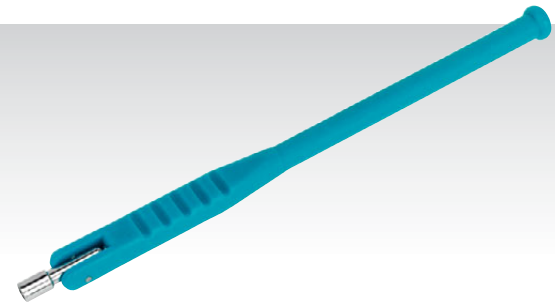

D

D SEE BELOW

Snap-in Tubeless Tyre Valves

Manufactured from EDPM rubber which prevents dry rot and wear.

Model No:	Wheel Rim Hole Size:	Length:	Pack Qty:
TV412	11.5mm (0.453")	22mm	100
TV413	11.5mm (0.453")	30mm	100
TV414	11.5mm (0.453")	38mm	100
TV418	11.5mm (0.453")	49mm	100



E

E SEE BELOW

Adhesive Wheel Weights - Zinc Plated Steel

Zinc plated adhesive wheel weights. Suitable for most European and Asian vehicles with alloy rims. Strong adhesive backing with a corrosion resistant finish. Manufactured to high quality to meet OEM standards.

Model No:	Type:	Weight:	Pack Qty:
WWSA5	Standard	5g	100 x Strip of 12
WWSA510	Standard	5/10g	100 x Strip of 8 (4 of each Weight)
WWSA5PC	Plastic Coated	5g	100 x Strip of 12
WWSA510PC	Plastic Coated	5/10g	50 x Strip of 8 (4 of each Weight)
WWSA5B	Black	5g	50 x Strip of 12
WWSA510B	Black	5/10g	50 x Strip of 8 (4 of each Weight)



F-I SEE BELOW

Exhaust Mounting Rubbers - Packs of 2

Packs of two rubber exhaust mounts. Common sizes to fit many models of vehicle.

Model No:	Dimensions (W x D x H):	Mounting Holes:	Distance Between Mounts:
F EX01	70 x 45 x 37mm	Ø9mm, 18 x 10mm Oval	33mm
G EX02	60 x 41 x 20mm	Ø10.5mm	24mm
H EX03	62 x 54 x 13.5mm	3.5mm High 180° Slots	11mm
I EX04	59 x 59 x 13.5mm	Ø30mm	n/a





A SEE BELOW
25ft Brake Pipe Copper Tubing

Model No:	Gauge:	Pipe Size:
CBP001	20	Ø3/16"
CBP002	22	Ø3/16"



B SEE BELOW
25ft Brake Pipe Seamless Tubing
Cupro-Nickel BS EN 12449 CW024A

Model No:	Gauge:	Pipe Size:
CNP316	22	Ø3/16"
CNP005	22	Ø5/16"



C VS5056
Brake Pipe Straightening Tool

Brake pipe straightener designed for use on automotive applications. This unique design is fast and easy-to-use. Suitable for 3/16"(4.76mm) cupro-nickel, copper and steel pipe. Features hole for marker pen.

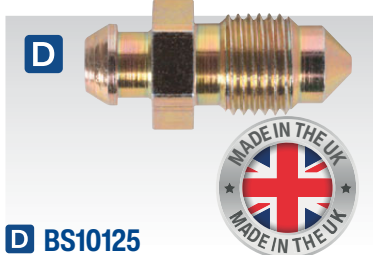

D BS10125
M10 x 25mm 1mm Pitch
Brake Bleed Screw

Pipe Size:	Ø3/16"
Length:	25mm
Thread Size:	M10 x 1mm
Pack Qty:	10

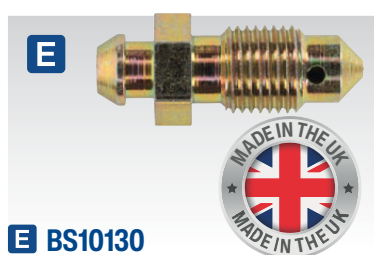

E BS10130
M10 x 30mm 1mm Pitch
Brake Bleed Screw

Pipe Size:	Ø3/16"
Length:	30mm
Thread Size:	M10 x 1mm
Pack Qty:	10



F BS7128
M7 x 28mm 1mm Pitch
Brake Bleed Screw

Pipe Size:	Ø3/16"
Length:	28mm
Thread Size:	M7 x 1mm
Pack Qty:	10



G BS8125
M8 x 24mm 1.25mm Pitch
Brake Bleed Screw

Pipe Size:	Ø3/16"
Length:	24mm
Thread Size:	M8 x 1.25mm
Pack Qty:	10



H BS1428
1/4"UNF x 28mm 28tpi
Brake Bleed Screw

Pipe Size:	Ø3/16"
Length:	28mm
Thread Size:	1/4"UNF x 28tpi
Pack Qty:	10



I BS6129
M6 x 29mm 1mm Pitch
Brake Bleed Screw

Pipe Size:	Ø3/16"
Length:	29mm
Thread Size:	M6 x 1mm
Pack Qty:	10



J BS3824
3/8"UNF x 32mm 24tpi
Brake Bleed Screw

Pipe Size:	Ø3/16"
Length:	32mm
Thread Size:	3/8"UNF x 24tpi
Pack Qty:	10



K BS382438
3/8"UNF x 38mm 24tpi
Brake Bleed Screw

Pipe Size:	Ø3/16"
Length:	38mm
Thread Size:	3/8"UNF x 24tpi
Pack Qty:	10



L AB160BN
160pc Bleed Nipple Assortment - Metric & Imperial

Contents (Approximate Quantity): Brake Bleed Screw Set; 3/8"UNF x 38mm 24tpi (x10), 3/8"UNF x 32mm 24tpi (x20), M6 x 29mm 1mm Pitch (x40), 1/4"UNF x 28mm 28tpi Long (x10), M8 x 24mm 1.25mm Pitch (x20), M7 x 28mm 1mm Pitch (x10), M10 x 30mm 1mm Pitch (x20), M10 x 25mm 1mm Pitch (x30)



M AB068BPN
200pc Brake Pipe Nut Assortment - Metric & Imperial

Contents (Approximate Quantity): Ø3/16" Pipe; 3/8"UNF x 24tpi Long Female (x10), M10 x 1mm Short Female (x30), 3/8"UNF x 24tpi Long Male (x10), M10 x 1mm Short Male (x100), M10 x 1mm Long Male (x5), M10 x 1mm Full Thread Male (x15), M10 x 1.25mm Long Male (x5), M10 x 1.25mm Short Male (x5), 3/8"BSF x 20tpi Long Male (x5), M12 x 1mm Part Thread Male (x5), Ø1/4" Pipe; 7/16"UNF x 20tpi Male (x5), 12mm x 1mm Male (x5)



A BN3824LF
Long Female - Imperial

Pipe Size:	Ø3/16"
Thread Size:	3/8"UNF x 24tpi
Type:	Long Female
Flare Type:	SAE
Pack Qty:	25



B BN10100
Short Female - Metric

Pipe Size:	Ø3/16"
Thread Size:	M10 x 1mm
Type:	Short Female
Flare Type:	DIN
Pack Qty:	25

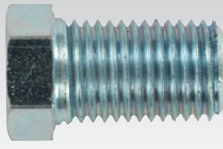

C BN3824LM
Long Male - Imperial

Pipe Size:	Ø3/16"
Thread Size:	3/8"UNF x 24tpi
Type:	Long Male
Flare Type:	SAE
Pack Qty:	25

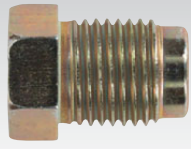

D BN10100SM
Short Male - Metric

Pipe Size:	Ø3/16"
Thread Size:	M10 x 1mm
Type:	Short Male
Flare Type:	DIN
Pack Qty:	25

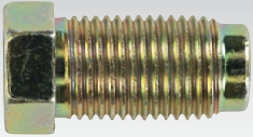

E BN10100LM
Long Male - Metric

Pipe Size:	Ø3/16"
Thread Size:	M10 x 1mm
Type:	Long Male
Flare Type:	DIN
Pack Qty:	25

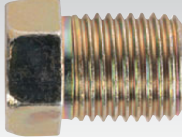

F BN10100FT
Full Thread Male - Metric

Pipe Size:	Ø3/16"
Thread Size:	M10 x 1mm
Type:	Full Thread
Flare Type:	DIN
Pack Qty:	25

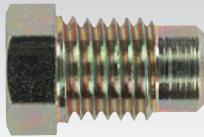

G BN10125LM
Long Male - Metric

Pipe Size:	Ø3/16"
Thread Size:	M10 x 1.25mm
Type:	Long Male
Flare Type:	DIN
Pack Qty:	25

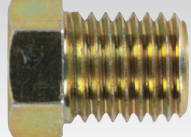

H BN10125SM
Short Male - Metric

Pipe Size:	Ø3/16"
Thread Size:	M10 x 1.25mm
Type:	Short Male
Flare Type:	DIN
Pack Qty:	25

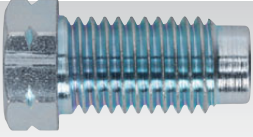

I BN3820LM
Long Male - Imperial

Pipe Size:	Ø3/16"
Thread Size:	3/8"BSF x 20tpi
Type:	Long Male
Flare Type:	SAE
Pack Qty:	25

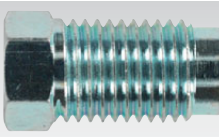

J BN71620
Male - Imperial

Pipe Size:	Ø1/4"
Thread Size:	7/16"UNF x 20tpi
Type:	Male
Flare Type:	SAE
Pack Qty:	10

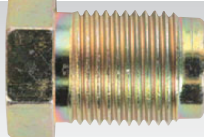

K BN121
Male - Metric

Pipe Size:	Ø1/4"
Thread Size:	M12 x 1mm
Type:	Male
Flare Type:	DIN
Pack Qty:	10

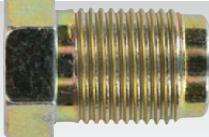

L BN12100PT
Part Thread Male - Metric

Pipe Size:	Ø3/16"
Thread Size:	M12 x 1mm
Type:	Male
Flare Type:	DIN
Pack Qty:	25

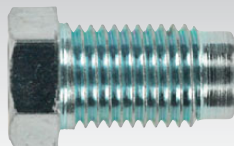

M BN3824SM
Short Male - Imperial

Pipe Size:	Ø3/16"
Thread Size:	3/8"UNF x 24tpi
Type:	Short Male
Pack Qty:	25

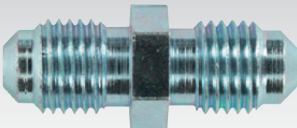

N BN3824MC
Male to Male - Imperial

Pipe Size:	Ø3/16"
Thread Size:	3/8"UNF x 24tpi
Type:	Male to Male
Pack Qty:	10

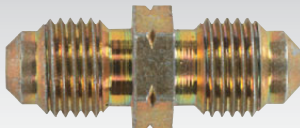

O BC101MC
Male to Male - Metric

Pipe Size:	Ø3/16"
Thread Size:	M10 x 1mm
Type:	Male to Male
Pack Qty:	10



P BC3824F
Female to Female - Imperial

Pipe Size:	Ø3/16"
Thread Size:	3/8"UNF x 24tpi
Type:	Female to Female
Pack Qty:	10

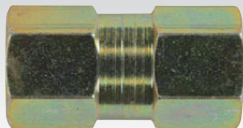

Q BC10100F
Female to Female - Metric

Pipe Size:	Ø3/16"
Thread Size:	M10 x 1mm
Type:	Female to Female
Pack Qty:	10



R BC38243WAY
3-Way - Imperial

Pipe Size:	Ø3/16"
Thread Size:	3/8"UNF x 24tpi
Type:	3-Way
Pack Qty:	1



S BC101003WAY
3-Way - Metric

Pipe Size:	Ø3/16"
Thread Size:	M10 x 1mm
Type:	3-Way
Pack Qty:	1



T VS4511
8 x 9mm Double End Brake Bleeder Spanner

For full details, see page 532.



A AB008GN
115pc Grease Nipple Assortment

Contents (Approximate Quantity): Straight; M6 x 1mm (x10), M8 x 1mm (x10), M8 x 1.25mm (x10), M10 x 1mm (x10), 45° Angle; M6 x 1mm (x10), M8 x 1mm (x5), M8 x 1.25mm (x10), M10 x 1mm (x10), 90° Angle; M6 x 1mm (x10), M8 x 1mm (x10), M8 x 1.25mm (x10), M10 x 1mm (x10)

B AB009GN
130pc Grease Nipple Assortment - Metric & Imperial

Contents (Approximate Quantity): Straight Metric; M6 x 1mm (x22), M8 x 1mm (x10), M10 x 1mm (x10), Straight Imperial; 1/4" BSP (x10), 1/4" UNF (x10), 1/8" BSP (x10), 45° Angle Metric; M6 x 1mm (x10), M8 x 1mm (x10), M10 x 1mm (x10), 45° Angle Imperial; 1/4" UNF (x10), 1/4" BSP (x8), 1/8" BSP Gas (x10)



C SEE BELOW
Straight Grease Nipples - Packs of 25

Straight grease nipples with Imperial/Metric threads.

Model No:	Thread Size:	Thread Type:	Pack Qty:
GNI16	1/4" BSP	Imperial	25
GNI17	1/4" UNF	Imperial	25
GNI18	1/8" BSP	Imperial	25
GNM18	M10 x 1mm	Metric	25
GNM19	M6 x 1mm	Metric	25
GNM20	M8 x 1mm	Metric	25
GNM21	M8 x 1.25mm	Metric	25



D SEE BELOW
45° Grease Nipples - Packs of 25

Angled grease nipples with Imperial/Metric threads.

Model No:	Thread Size:	Thread Type:	Pack Qty:
GNI10	1/4" UNF	Imperial	25
GNI11	1/8" BSP	Imperial	25
GNI12	1/4" BSP	Imperial	25
GNM10	M10 x 1mm	Metric	25
GNM11	M8 x 1mm	Metric	25
GNM12	M8 x 1.25mm	Metric	25
GNM13	M6 x 1mm	Metric	25



E SEE BELOW
90° Grease Nipples - Packs of 25

Angled grease nipples with Imperial/Metric threads.

Model No:	Thread Size:	Thread Type:	Pack Qty:
GNI13	1/4" BSP	Imperial	25
GNI14	1/4" UNF	Imperial	25
GNI15	1/8" BSP	Imperial	25
GNM14	M10 x 1mm	Metric	25
GNM15	M6 x 1mm	Metric	25
GNM16	M8 x 1mm	Metric	25
GNM17	M8 x 1.25mm	Metric	25



SINGLE OR
 PACK OF 5

F SEE BELOW
4-Jaw Heavy-Duty Hydraulic Connectors
 4-Jaw heavy-duty hydraulic connector with 1/8" BSP thread.

Model No:	Thread Size:	Pack Qty:
GGE1	1/8" BSP	1
GGE5	1/8" BSP	5



GREASE GUNS
 For our full range of Grease Guns see pages 640 to 645, or visit www.sealey.co.uk.



G SEE BELOW
Flexible Rubber Grease Gun Delivery Hoses 1/8" BSP

Flexible rubber hoses for manual grease guns. Not to be used on air operated grease guns.

Model No:	Length:	Thread Size:
GGH300	300mm	1/8" BSP
GGH450	450mm	1/8" BSP

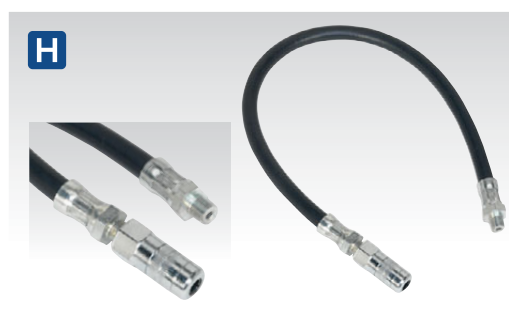

H SEE BELOW
Flexible Rubber Grease Gun Delivery Hoses with 4-Jaw Connector

Flexible rubber hoses for manual grease guns. Not to be used on air operated grease guns. Supplied with 4-jaw grease gun end.

Model No:	Length:	Thread Size:
GGHE300	300mm	1/8" BSP
GGHE450	450mm	1/8" BSP



I SEE BELOW
Flexible Rubber Delivery Hoses with 4-Jaw Connector & Quick Release Coupling

Flexible rubber snap-on extension with end hose. Supplied with 4-jaw grease gun end.

Model No:	Length:	Thread Size:
GGSF300	300mm	1/8" BSP
GGSF450	450mm	1/8" BSP

A

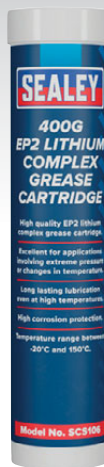

A SCS106
400g EP2 Lithium Complex Grease Cartridge

High quality EP2 lithium complex grease cartridge. Suitable for applications involving extreme pressure or changes in temperature.

B



B SEE BELOW
400g Screw-Type EP2 Lithium Grease Cartridge

Screw-type multipurpose EP2 Lithium grease cartridges suitable for use with Model No's AK4403, AK52 & AK53 Grease Guns. Lithium grease ideal for a wide range of lubrication applications. Cartridge screws directly into grease gun head making it quicker and cleaner than standard cartridges.

Thread Size:	M33 x 2.5mm
Model No:	Pack Qty:
SCS107	1
SCS108	12



GREASE GUNS

For our full range of Grease Guns, see page 642.

C



C SEE BELOW
400g EP2 Lithium Grease Cartridge

Multipurpose EP2 Lithium grease cartridge suitable for use with all plunger type grease guns. Ideal for a wide range of applications.

Model No:	Pack Qty:
SGC1	1
SGC12	12

D



E



F



G



D SCS110
500g Red Rubber Grease Tin

Lubricating red rubber grease, ideal for use on brake assemblies. Also compatible with nitrile O-rings and seals.

E SCS104
500g Bentone Brake Grease Tin

Anti-seize bentone grease suitable for extreme heat applications including brakes and wheel bearings. Water-resistant, compatible with ABS brakes and protects against scratches and corrosion.

F SCS109
500g Copper Grease Tin

Anti-seize copper grease, protects against rust, oxidation and other corrosion.

G SCS102
500g Clear Silicone Grease Tin

Clear silicone grease for use on UPVC push-fit soil and waste drainage and insulation of electrical terminals.

H



H SCS103
500g Aluminium Anti-Seize Compound Tin

Aluminium anti-seize compound, for use on all studs, nuts, bolts and other threaded connections.

I



I AK51
100g Mini Grease Applicator

Mini grease applicator supplied with 100g lithium grease cartridge. Ideal for use in hard-to-reach areas such as engine bays and door hinges. Supplied with accurate dispensing nozzle for precision greasing.

J Replacement Grease Cartridge: AK51C

J



DISPOSABLE GLOVES
For full details, see page 1285.



A SEE BELOW
500ml Air Tool Oil

Maintain your air tools with a quality high performance air tool oil containing mineral lubricants and detergents.

Model No:	Pack Qty:	Size:
ATO500S	1	500ml
ATO/500	12	500ml

B SEE BELOW
1L Air Tool Oil

Maintain your air tools with a quality high performance air tool oil containing mineral lubricants and detergents.

Model No:	Pack Qty:	Size:
ATO1000S	1	1L
ATO/1000	12	1L

C CS01L
1L Chainsaw Oil

Suitable for the lubrication of cutter bars and chains of pump and pressure-fed chainsaws requiring an ISO 220 or SAE 50 lubricant. Tacky formula prevents oil fling and splatter. Extends the lifespan of your chainsaw by protecting against sap and resin. Prevents corrosion of the chain and bar.

Size:	1L
-------	----

D SCS0105
5L Universal Maintenance Fluid with PTFE

Universal maintenance fluid. Protects all metals. Displaces moisture and contains rust inhibitor. Cleans, lubricates and degreases target area. Silicon-free formula suitable for bodyshop use. Ideal for using with small spray trigger bottles.



E SEE BELOW
500ml Hydraulic Jack Oil

Hydraulic oil recommended for use in all jacks (trolley and bottle) and cranes. N.B. Never use brake fluid to top-up a hydraulic unit.

Model No:	Pack Qty:	Size:
HJO500MLS	1	500ml
HJO/500ML	12	500ml

F SEE BELOW
5L Hydraulic Jack Oil

Hydraulic oil recommended for use in all jacks (trolley and bottle) and cranes. N.B. Never use brake fluid to top-up a hydraulic unit.

Model No:	Pack Qty:	Size:
HJO5LS	1	500ml
HJO/5L	4	500ml

G NCO/5L
5L Neat Cutting Oil

Suitable for lubricating and cooling drill bit or blade and workpiece when cutting mild steel.

H SCO/5L
5L Soluble Cutting Oil

Suitable for lubricating and cooling drill bit or blade and workpiece when cutting mild steel.



I SEE BELOW
Compressor Oil

Standard Compressor Oil		
Model No:	Size:	Pack Qty:
1 CPO1S	1L	1
2 CPO/1	1L	12
3 CPO/5	5L	1

Fully Synthetic Compressor Oil		
Model No:	Size:	Pack Qty:
4 FSO1S	1L	1
5 FSO5	5L	1

Screw Compressor Oil		
Highly refined mineral oil suitable for use in Sealey and other leading brands of screw compressors.		
Model No:	Size:	Pack Qty:
6 SCPO1S	1L (ISO VG 46)	1
7 SCPO5	5L (ISO VG 46)	1



A



A SCS018S
500ml Universal Maintenance Lubricant with Easy-Straw Spray Head & PTFE

Easy-straw spray head allows you to change between conventional nozzle and extension tube. Protects all metals. Displaces moisture and contains a protective rust inhibitor. Cleans, lubricates and degreases target area. Silicon-free formula suitable for bodyshop use.



B

BULK PACK



B SEE BELOW
500ml Universal Maintenance Lubricant with PTFE

Universal maintenance spray. Protects all metals. Displaces moisture and contains a protective rust inhibitor. Cleans, lubricates and degreases target area. Silicone-free formula suitable for bodyshop use.

Model No:	Pack Qty:
SCS010	6
SCS010S	1



C



C SCS036S
500ml Freeze Shock & Release Spray Lubricant

Aids release of corroded and seized parts. Fast shock freeze action penetrates the corroded area. Displaces moisture. Penetrates, lubricates and helps prevent future corrosion.



D



D SCS019S
500ml Clear Multipurpose Fine Oil Lubricant

Suitable for wire rope, chains, cables, hinges, springs and slides. Cleans lubricates and protects against rust. General application for all types of machinery. Higher grade general-purpose lubricant, accurate and economical application.



E



E SCS022S
500ml Graphited Penetrating Oil Lubricant

Low viscosity high penetrating liquid. Frees seized nuts, bolts, locks and rusted parts. Lubricates and protects. Leaves a protective barrier. General application for all types of machinery. Higher grade general-purpose lubricant, accurate and economical application.



F

BULK PACK



F SEE BELOW
500ml Clear Chain & Cable Lubricant

Suitable for wire rope, chains, cables, hinges, springs and slides. Anti-fling formula, ideal for motorcycle chains and forklift masts. Penetrates and protects. Lubricates leaving a protective barrier.

Model No:	Pack Qty:
SCS017	6
SCS017S	1



G

BULK PACK



G SEE BELOW
500ml Clear Grease Lubricant

Clear grease ideal for visible areas such as door latches, chains and linkages. Penetrates and protects. Lubricates, leaving a protective barrier. Silicon-free formula suitable for bodyshop use.

Model No:	Pack Qty:
SCS012	6
SCS012S	1



H

BULK PACK



H SEE BELOW
500ml White Grease Lubricant with PTFE

White grease suitable for locks, hinges and all moving applications. Penetrates and protects. Lubricates, leaving a protective barrier. Silicon-free formula suitable for bodyshop use.

Model No:	Pack Qty:
SCS014	6
SCS014S	1



I



I SCS016S
500ml Copper Grease Lubricant

Copper grease for high temperature applications, used on brakes, brake linkages and exhaust manifolds, studs and nuts. Specially formulated for today's service engineers, automotive and DIY enthusiast.



J



J SCS043S
500ml Rubber Care Silicone-Free Lubricant

Maintains rubber seals on doors, tailgates and bonnets. Also great for rubber trim and rubber mats. Lessens the effect of traffic spray, salt water, diluted acids and alkaline. Inhibits rubber parts ageing or cracking and stops screeching noises from dry rubber. Silicone-free formula.



K



K SCSCF400
500ml Tapping & Cutting Fluid

High quality tapping and cutting fluid. Suitable for a wide range of machining and drilling operations. High viscosity with excellent lubricating properties.



To help you identify the correct product for you, we have colour-coded our cans.

- Grease/Lubricant
- Cleaner
- Glue
- Protect
- Gas
- Repair
- Paint





A SCS042S
500ml Paint & Gasket Remover

Used to remove gaskets from engine components, water pumps and manifolds. Removes paints, lacquers and varnishes. Also removes rubber residue from wheel hubs before fitting new or repaired tyres and burnt oil deposits from engine components.



B SEE BELOW
500ml Brake Parts Cleaner

Removes grease, brake fluid, oils and dust. Helps maximize braking efficiency. Prevents dust escaping into the atmosphere. Quick drying and leaves no residue. Environmentally friendly formula.



C SEE BELOW
500ml Electrical Contact Cleaner

Removes carbon residues, grease, oil and tar. Improves conductivity which helps prevent arcing and electrical breakdown. Ideal for ignition components and other precision parts. Quick drying formula which leaves no residue.



Model No:	Pack Qty:
SCS021	6
SCS021S	1



D SEE BELOW
150ml Air Conditioning Refresher

Air conditioning refresher with an apple fresh fragrance, eliminates odours from air-con and heating systems, leaving the system clean and free of germs.

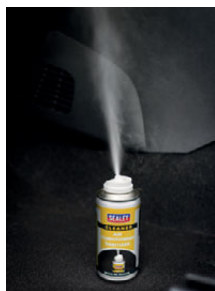

Model No:	Pack Qty:
SCS023	6
SCS023S	1



E SCS045S
500ml Multipurpose Foam Cleaner

Suitable for use on upholstery, glass, ceramics, laminates, PVC, office furniture and work surface areas. Immediate foaming action lifts grime. Wipes away easily and doesn't drip or run.



F SCS039S
500ml Spray Adhesive

Repairs and maintains most types of substrate and trim. Excellent for use on roof and trim lining, upholstery and backed carpet. Suitable for paper, card, fabric, foam and other similar materials or onto metals and ceramics, glass and wood.



G SEE BELOW
500ml Throttle Body & Carburettor Cleaner

Removes gum, resin and general deposits. For all types of carburettors, fuel injection systems and automatic chokes. Improves performance and economy. Will not damage catalytic converters or lambda sensors.

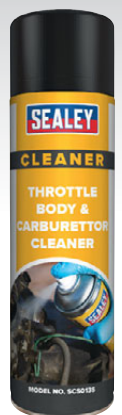

Model No:	Pack Qty:
SCS013	6
SCS013S	1



H SCS015S
500ml Battery Terminal Spray

Helps prevent the furring and oxidation of battery terminals. Repels moisture and provides a protective film. Suitable for use on battery terminals, clips and connectors. Acid leak indicator, which turns red when acid is detected. Anti-corrosive.



I SEE BELOW
200ml Butane Gas Refill

High purity butane gas, helps prevent blocked nozzles, which can occur when using conventional lighter gas chargers. Used for lighters, heating torches and butane soldering irons.

Model No:	Pack Qty:
SCS035	6
SCS035S	1



J SCSTR500
500ml Emergency Tyre Repair Foam

Suitable for cars, vans, trailers and motorcycles. Seals up to 5mm punctures.





A-G SEE BELOW
500ml Aerosol Spray Paints

Outstanding coverage. Provides a tough durable finish. Good adhesion to primed surfaces. Resistant to colour fade. For use on a range of metals, wood and plastic. Fast drying.

Model No:	Pack Qty:	Colour:	Finish:
A SCS025	6	Black	Gloss
B SCS025S	1	Black	Gloss
C SCS026	6	Black	Matt
D SCS026S	1	Black	Matt
E SCS028S	1	Black	Satin
F SCS031S	1	Silver	Metallic
G SCS032S	1	White	Gloss



H SEE BELOW
500ml Stone Chip Paint

Fast drying. Protects ferrous metals from corrosion. Adheres to metal and plastic surfaces. For use on sills, wheels arches and underbodies.

Model No:	Pack Qty:
SCS060	6
SCS060S	1



I-M SEE BELOW
500ml Paints

Outstanding coverage, excellent adhesion and fast drying. For use on a range of metals, wood and plastics prior to top coating. Model No. SCS034S is 99% pure zinc powder giving it enhanced anti-corrosive protection. SCS061S and SCS061 High build primer fills small scratches and dents for a smooth finish.

Model No:	Pack Qty:	Bulk Model No:	Pack Qty:	Colour:
I SCS029S	1	n/a	n/a	Grey
J SCS030S	1	n/a	n/a	Red Oxide
K SCS034S	1	n/a	n/a	Grey Zinc
L SCS061S	1	SCS061	6	Filler
M SCS062S	1	SCS062	6	Grey Etch



N SEE BELOW
200ml Super Glue Activating Aerosol

Radically reduces the time adhesives and super glues take to cure. Ideal for large gap fills up to 0.4mm and porous material that are ordinarily troublesome to glue. Can be used on MDF, wood, glass, metal and most plastics.

Model No:	Pack Qty:
SCS300	6
SCS300S	1

O SEE BELOW
500ml Cutting Compounds

Fine/medium cutting compounds will help to restore gloss and remove moderate swirl marks and fine scratches in all paintwork, without drying out or generating a large amount of polishing dust.

Model No:	Compound:
SCS700	Fine
SCS701	Medium

P SCS702
500ml Super Polymer Polish

Super polymer polish helps to protect and restore gloss paintwork. For use with dual action and rotary polishers. Contains premium carnauba wax for unsurpassable shine. Built-in salt inhibitor builds a durable coating for long term lustre, with repeated use.



Q-R SEE BELOW
Paint Filters - Packs of 10

In-line suction pot and gravity cup filters.

Model No:	Type:
Q ILF/PF10	Suction Feed
R ILF/GF10	Gravity Feed



A SEE BELOW
20g Fast Setting Super Glue
 A low viscosity adhesive that sets fast. Bonds materials such as metal, rubber, plastics and wood in seconds.

Model No:	Pack Qty:
SCS302S	1
SCS302	20



B SEE BELOW
20g Rapid Set Super Glue
 A high viscosity adhesive that sets fast. Bonds materials such as metal, rubber, plastics and wood in seconds.

Model No:	Pack Qty:
SCS304S	1
SCS304	20



C SEE BELOW
20g Non-Drip Gel Super Glue
 Non-drip thick gel adhesive that sets fast. Perfect for vertical repairs and porous materials. Bonds materials such as metal, rubber, plastics and wood in seconds.

Model No:	Pack Qty:
SCS303S	1
SCS303	20



D NEW
SCS500
25ml Rapid Set MMA Adhesive
 Methyl Methacrylate Adhesive, especially suited to bonding a wide variety of dissimilar materials including metals, plastic, carbon fibre and wood. High tension strength, resistant to shear, peel weathering, solvents and impact stress. Widely used in automotive, aerospace, marine, electronics and transport industries.

Gap Fill:	1-4mm
Temperature Range:	-50°C to +120°C
Cure Time:	Working Time; 4-6 minutes, Fixture Time; 12-15 minutes



E SCS301
5g Fast Setting Super Glue
 A low viscosity adhesive that sets fast. Bonds materials such as metal, rubber, plastics and wood in seconds.

Size:	5g Bottle
-------	-----------



F SCS572
50ml Air & Brake Line Sealant
 Used for fine and coarse threads up to 75mm(3") in diameter. 60 Hours to fully cure, which allows time to realign joints. Contains PTFE.

Size:	50ml Concertina Applicator
-------	----------------------------



G SCSKIT1
10pc Adhesive & Sealant Kit
 Combination kit featuring the most popular adhesives and sealants, including thread, nut and stud lock, quick set metal and epoxy, super glues along with gasket and air/brake line sealants. Ideal for the workshop or mobile engineers and mechanics. Supplied in a tough storage case.

Contents:	SCS222S, SCS243S, SCS601S, SCS271S, SCS302S, SCS303S, SCS380, SCS401, SCS572, SCS574
-----------	--



H SCS401
25ml Quick-Set Epoxy Adhesive
 Starts to hold in just 5 minutes. Suitable for bonding metal and metal alloys, most plastics, fibreglass, stone, ceramics and glass etc. Creates an excellent waterproof and impact resistant bond.

Size:	25ml Syringe
Temperature Range:	-40°C to +60°C
Full Cure Time:	24hr Approx.



I SCS400
25ml Slow Set Epoxy Adhesive
 Workable for 20 minutes. Joins a huge array of materials, metals, most plastics, fibreglass, stone, ceramics and wood. Once cured, it can be machined, sanded and even painted.

Size:	25ml Syringe
Gap Fill:	Up To 2mm
Temperature Range:	-50°C to +80°C
Full Cure Time:	72hr Approx.



J SCS380
25ml Quick-Set Liquid Metal
 For the bonding and repair of most metals. Great for forming and repairing metal housings and sheet steel. When fully cured can be filed, drilled, tapped and painted.

Size:	25ml Syringe
Full Cure Time:	72hr Approx.



K SCS390
114g Quick-Set Putty Metal
 Hand-kneadable, non-rusting, steel reinforced epoxy putty. Steel stick repairs or rebuilds anything made of metal*.

Size:	114g Tube
Full Cure Time:	72hr Approx.

*Excluding aluminium.



A SEE BELOW
50ml Low Strength Thread Lock

A low strength thread lock for all types of metal threaded fasteners. Prevents fasteners loosening due to vibration and seals against leakage, whilst still allowing easy disassembly of treated parts. Fills gaps up to 0.5mm.

Model No:	Pack Quantity:
SCS222S	1
SCS222	12
Fixture Time:	15min @ 20°C
Full Cure Time:	12hr @ 20°C



B SEE BELOW
50ml Medium Strength Nut Lock

A medium to high strength nut lock for all types of metal threaded fasteners. Can be used on plated parts up to 50mm.

Model No:	Pack Quantity:
SCS243S	1
SCS243	12
Fixture Time:	5-8min @ 23°C
Full Cure Time:	4hr @ 23°C on Steel 24hr @ 23°C on Zinc



C SEE BELOW
50ml High Strength Stud Lock

High strength stud locking adhesive for all types of metal. Rapid fixing time of 15-20 minutes on normal plated, oiled metal surfaces and fixtures. Works on steel, aluminium, stainless steel and zinc.

Model No:	Pack Quantity:
SCS271S	1
SCS271	12
Fixture Time:	15-20min @ 23°C
Full Cure Time:	24hr @ 23°C



D SEE BELOW
50ml High Strength Bearing Fit Retainer

Retains bearings, even under high rotational loading. Keeps full strength with no fatigue under load stress and has low corrosiveness.

Model No:	Pack Quantity:
SCS601S	1
SCS601	12



E SEE BELOW
50ml High Strength Retainer

Designed for cylindrical fitting parts. Cures once confined in the absence of air in close fitting joints.

Model No:	Pack Quantity:
SCS638S	1
SCS638	12



F SCS574
50ml Multi Gasket Sealant Orange

Immediate low resistance on assembly and cures once confined in the absence of air in close fitting joints. High oil resistance with water and glycol tolerance. Supplied in an easy-to-use concertina applicator.



G SCS591
200ml High Temperature Gasket Sealant Black

Gasket sealant to replace original gaskets. Used as an adhesive to bond metal, rubber and glass etc. Supplied in a flow controllable power can. Temperature range -50°C to 180°C.



H SCS200
150ml Exhaust Assembly Paste

For ease of assembly and creates gastight exhaust joints. Suitable for use with Model No. AK3901 Caulking Gun.



I-L SEE BELOW
Fast-Fix Filler & Adhesives

Two part (adhesive and filler powder) repair system with unique reinforcing and filling feature. Cracks, holes and gaps can be repaired so that the damaged area is taken back to original shape/profile. Rapid solidification and strong cohesive force designed to bond rubber, copper, steel and aluminium, as well as most plastics.

Model No:	Colour:
I SCS906	Clear
J SCS908	Black
K SCS909	Grey
L SCS910	White



Buy in the pack sizes stated wherever you see this logo, for further savings on our range of consumable products.



A SEE BELOW
25mm x 25m
Emery Rolls - Blue Twill

Model No:	Width:	Length:	Grit:
ER252540	25mm	25m	40
ER252560	25mm	25m	60
ER252580	25mm	25m	80
ER2525120	25mm	25m	120
ER2525150	25mm	25m	150



B SEE BELOW
25mm x 50m
Emery Rolls - Blue Twill

Model No:	Width:	Length:	Grit:
ER255040	25mm	50m	40
ER255060	25mm	50m	60
ER255080	25mm	50m	80
ER2550120	25mm	50m	120
ER2550150	25mm	50m	150



C SEE BELOW
50mm x 50m Emery Rolls - Blue Twill

Model No:	Width:	Length:	Grit:
ER505040	50mm	50m	40
ER505080	50mm	50m	80



D SEE BELOW
25mm x 50m
Engineer's Emery Rolls Brown

Model No:	Width:	Length:	Grit:
ERB255080	25mm	50m	80
ERB2550120	25mm	50m	120



E SEE BELOW
50mm x 50m
Engineer's Emery Rolls Brown

Model No:	Width:	Length:	Grit:
ERB505080	50mm	50m	80
ERB5050120	50mm	50m	120



F ERB5050320
50mm x 50m Engineer's
Emery Roll Brown

Engineering grade brown emery roll, ideal for hand operation. Designed for rust removal, finishing and polishing. Not for use on wood. Supplied in a dispenser box.

Grit:	320
Length:	50m



G SEE BELOW
Fibre Backed Sanding Discs

Suitable for working on wood or metal surfaces. For use with portable disc sanders.

Model No:	Diameter:	Grit:	Pack Qty:
WSD424	Ø100mm	24	25
FBD10036	Ø100mm	36	25
WSD440	Ø100mm	40	25
FBD10050	Ø100mm	50	25
WSD460	Ø100mm	60	25
WSD480	Ø100mm	80	25
WSD4120	Ø100mm	120	25
WSD4524	Ø115mm	24	25
FBD11536	Ø115mm	36	25
WSD4540	Ø115mm	40	25
FBD11550	Ø115mm	50	25
WSD4560	Ø115mm	60	25

Model No:	Diameter:	Grit:	Pack Qty:
WSD4580	Ø115mm	80	25
WSD45120	Ø115mm	120	25
WSD524	Ø125mm	24	25
WSD540	Ø125mm	40	25
WSD560	Ø125mm	60	25
WSD580	Ø125mm	80	25
WSD5120	Ø125mm	120	25
WSD724	Ø175mm	24	25
WSD740	Ø175mm	40	25
WSD760	Ø175mm	60	25
WSD780	Ø175mm	80	25
WSD7120	Ø175mm	120	25





A SEE BELOW
280 x 230mm Glasspaper - Packs of 5

Model No:	Grit:
CGF	Fine
CGM	Medium
CGC	Coarse
CGA	Assorted

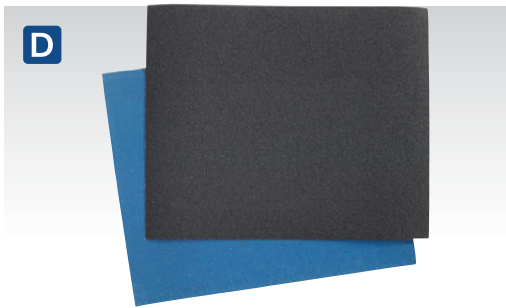

D SEE BELOW
230 x 280mm Emery Sheets - Blue Twill
Packs of 25

Model No:	Grit:
ES232840	40
ES232860	60
ES232880	80
ES2328120	120
ES2328150	150



F SEE BELOW
Sanding Rolls

Model No:	Grit:	Width:	Length:
WSR560	60	115mm	5m
WSR5120	120	115mm	5m
WSR5180	180	115mm	5m
WSR5240	240	115mm	5m
WSR1040	40	115mm	10m
WSR1060	60	115mm	10m
WSR1080	80	115mm	10m
WSR10120	120	115mm	10m
WSR10180	180	115mm	10m
WSR10240	240	115mm	10m



B NEW
B SEE BELOW
450g Steel Wool

Model No:	Grade:
SW00	#00 Extra Fine
SW0	#0 Fine
SW1	#1 Medium
SW3	#3 Coarse



E SEE BELOW
230 x 280mm Production Paper
Packs of 25

Model No:	Grit:
PP232840	40
PP232860	60
PP232880	80

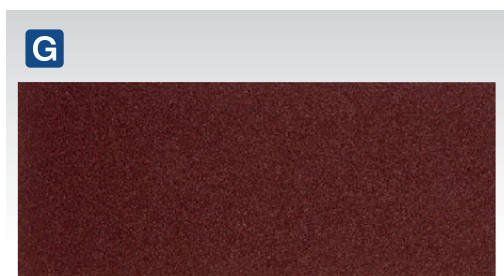

G SEE BELOW
115 x 280mm Orbital Sanding Sheets
Packs of 5

Model No:	Size:	Grit:
CS11540/5	115 x 280mm	40
CS11560/5	115 x 280mm	60
CS11580/5	115 x 280mm	80
CS115100/5	115 x 280mm	100
CS115120/5	115 x 280mm	120
CS115A/5	115 x 280mm	Assorted Pack

H-J SEE BELOW
150 x 230mm Abrasive Finishing Pads
Packs of 10

Long lasting. Flexible for contoured work surfaces. Waterproof and solvent resistant.

Model No:	Colour/Grade:	Application:
H HP1523F	Green/Fine	General Purpose
I HP1523M	Maroon/Medium	Prior to Primer
J HP1523UF	Grey/Ultra-Fine	Prior to Clear Coat

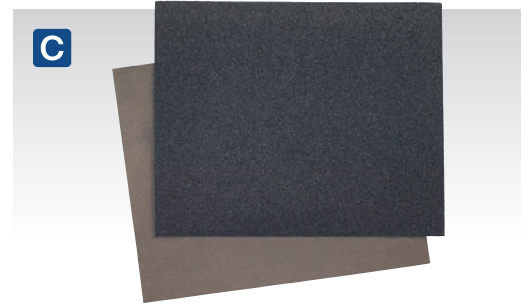

C SEE BELOW
230 x 280mm Wet & Dry Paper
Packs of 25

Model No:	Grit:
WD2328120	120
WD2328180	180
WD2328240	240
WD2328320	320
WD2328400	400
WD2328600	600
WD2328800	800
WD23281000	1000
WD23281200	1200
WD23281500	1500
WD23282000	2000



A



A SOL250
250g Flux Paste

Flux paste initially adheres components in place, it is then heated, melting the paste and forming a mechanical, as well as an electrical, connection.

B



B SOLFLUX
500ml Solder Fluxing Fluid

Liquid flux is a key component to soldering because it removes oxidation that prevents solder from bonding to metals. Soldering even freshly cleaned metals requires flux because metals oxidize extremely fast under high soldering temperatures.

C



C SD151
Solder Sucker

Aluminium/composite construction suitable for sucking excess solder from joints and components. Push-button operation. Fitted with hard-wearing Teflon® tip.

E



E SWD1
Soldering Wire Dispensing Stand

Steel construction supports sizes of wire up to 1kg. Features soldering wire guide and smooth reel action for improved work efficiency. Fitted with sheathed soldering iron holder for storing iron even when hot. Supplied with soldering sponge.

D



D SW20
Lead-Free Soldering Wire Dispenser Tube

Tube of flux-cored lead-free wire for general-purpose soldering.

Size: 10g

F

G

H

I



F-I SEE BELOW
Solder Wire Quick Flow 40/60

Quick flow solder with a unique resin 'core' making it suitable for brass and copper. Precision wound solder wire dedicated for manual (hand soldering), automated and high speed soldering applications. For strong joints and reliable connections. For professional use only.

	F	G	H	I
Model No:	SOL10	SOL16	SOL18	SOL22
Reel Size:	0.5kg	0.5kg	0.5kg	0.5kg
Grade:	2%	2%	2%	2%
Thickness:	3.25mm/10SWG	1.6mm/16SWG	1.2mm/18SWG	0.7mm/22SWG
Tin/Lead:	40/60	40/60	40/60	40/60
Melting Point:	183-234°C	183-234°C	183-234°C	183-234°C

230V

30W

40W

100W



J-L SEE BELOW
Soldering Irons

Class 1 electrically insulated soldering irons with cool grip handle which stays comfortable during prolonged use. Fitted with replaceable soldering tip. Includes 1.5m cable with 3-pin plug.

Model No:	Power Rating:
J SD30	30W
K SD40	40W
L SD100	100W

Replacement Soldering Tips: Straight; SD30/ST, SD40/ST, SD100/ST7, Curved; SD30/CT, SD40/CT, SD100/CT7

M

M SEE BELOW
18SWG Nails

Model No:	Length:	Pack Qty:	Applications:
SAAN1810	10mm	5000	SA791, SA792
SAAN1815	15mm	5000	SA791, SA792
SAAN1820	20mm	5000	SA791, SA792
SAAN1825	25mm	5000	SA791, SA792
SAAN1830	30mm	5000	SA791, SA792
SAAN1832	32mm	5000	SA791, SA792
SAAN1835	35mm	5000	SA791, SA792
SAAN1840	40mm	5000	SA791, SA792
SAAN1850	50mm	5000	SA791, SA792

N

N SEE BELOW
8SWG Staples

Model No:	Length:	Crown:	Pack Qty:	Applications:
SAAS1810	10mm	5.7mm	5000	SA789, SA792
SAAS1813	13mm	5.7mm	5000	SA789, SA792
SAAS1816	16mm	5.7mm	5000	SA789, SA792
SAAS1819	19mm	5.7mm	5000	SA789, SA792
SAAS1825	25mm	5.7mm	5000	SA789, SA792
SAAS1828	28mm	5.7mm	5000	SA789, SA792
SAAS1832	32mm	5.7mm	5000	SA789, SA792
SAAS1835	35mm	5.7mm	5000	SA792
SAAS1838	38mm	5.7mm	5000	SA792
SAAS1840	40mm	5.7mm	5000	SA792



A AK7061
Heavy-Duty Staple & Brad Nail Gun
 3-in-1 Staple and nail gun. Fitted with adjustable power control and staple remover. Features removable sole plate for easy clearance of blockages. Supplied with starter pack of 1500 nails and staples. Suitable for a wide range of applications. Supplied in storage case. See page 271 for full specification.

B SEE BELOW Not Illustrated
Staples, Hoops & Nails for AK7061
 A selection of replacement staples, hoops and nails for Model No. AK7061 and other popular brands.



Model No:	Type/Size:	Pack Qty:
AK7061/8	Staples/6mm	500
AK7061/9	Staples/8mm	500
AK7061/2	Staples/10mm	500
AK7061/3	Staples/12mm	500
AK7061/4	Staples/14mm	500
AK7061/1	Nails/10mm	500
AK7061/5	Nails/12mm	500
AK7061/7	Nails/14mm	500
AK7061/6	Hoops/12mm	500

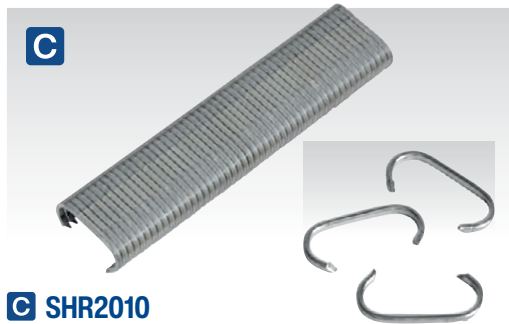

C SHR2010
Steel Hog Rings 50 Strips of 50
 Steel hog rings with galvanised coating. Pointed ends make these hog rings particularly suited to vehicle upholstery repairs. Suitable for a wide variety of uses. 2500 Hog rings per box as 50 strips of 50. See page 593 for our Hog Ring Pliers.



D AK5228
Composite Razor Blade - Pack of 100
 Pack of 100 composite razor blades. Suitable for use with Blade Holder, Model No. AK5227.



E SEE BELOW
Razor Scraper Blades
 Compatible with Model No's AK867, AK52504, VS500 and other popular brands.

Model No:	Blade Type:	Pack Qty:
AK867/1	Thin	5
AK867B100	Thin	100



F AK867
Retracting Razor Scraper with Blades
 Chrome plated steel construction with retracting blade carrier for extra safety. Supplied with five spare blades.
Length: 100mm

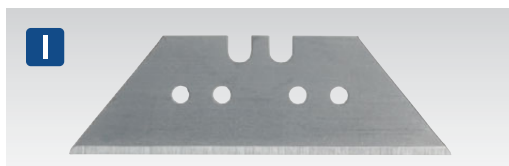

I AK86/B
Utility Knife Blade - Pack of 10
 Suitable for use with Sealey and other brands of standard/traditional utility knives. Compatible with Model No's AK86, AK8603, AK8604, AK8606, AK8607, AK863, AK8631, PK17, PK19, PK20, PK23, PK27, PK29, PK30, PK37, PK38, PK5, S0529 and S0555.



G HSB/10VP
300mm Bi-Metal 18/24/32tpi Vari-Pitch Hacksaw Blade - Pack of 10
 Flexible bi-metal blades with unique variable pitch profile teeth for superior performance on a wide range of materials. Variable pitch 18-24-32tpi. Manufactured from high quality steel to ensure a long life.



H SEE BELOW
Bi-Metal Hacksaw Blades HSS
 Flexible bi-metal HSS blades with superior performance on a wide range of materials.

Model No:	Tooth Pitch:	Pack Qty:
HSB0218	18tpi	2
HSB0224	24tpi	2
HSB0232	32tpi	2
HSB0518	18tpi	5
HSB0524	24tpi	5
HSB0532	32tpi	5
HSB1018	18tpi	10
HSB1024	24tpi	10
HSB1032	32tpi	10
HSB5024	24tpi	50

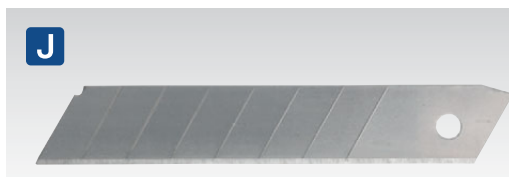

J AK86R/B
Snap-Off Blade - Pack of 10
 Suitable for use with retractable snap-off knives.

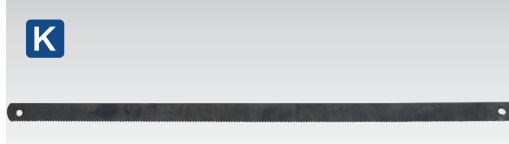

K S0527.B
150mm Junior Hacksaw Blade - Pack of 10
 150mm Hacksaw blades suitable for Model No. S0527.

EASY-MATCH Trim Clips shown at actual size for easy identification.

Trim Clips

A comprehensive range of panel, trim and moulding clips suitable for a wide variety of popular vehicles. All clips are manufactured to OEM specifications and supplied in convenient resealable bags of 20 clips or assortment boxes denoting their application. See www.sealey.co.uk for a full listing of applications



Ford, GM, Honda, Peugeot, Suzuki & Universal

A TCFT100AS

Fir Tree Clip Assortment - Pack of 100

Contents: TCFT2022U (x10), TCFT1830 (x10), TCFT1823U (x10), TCFT24207U (x10), TCFT2018U (x10), TCFT1820 (x10), TCFT2420U (x10), TCFT1820P (x10), TCFT1823 (x10), TCFT1418 (x10)

EASY-MATCH

Trim Clips shown actual size for easy identification. All pictures of our trim clips on pages 1126 to 1133 are shown actual size. This enables you to match your trim clip to the right replacement, saving errors or any downtime.

For our full range of Trim Tools see pages 592 to 593.

Colour Coded for Quick Selection

Fir Tree	Locking Nuts
Under Bonnet	Panel Clip
Push/Push In	Screw Rivet
Retaining Clip	Moulding
Weather Strip	Miscellaneous

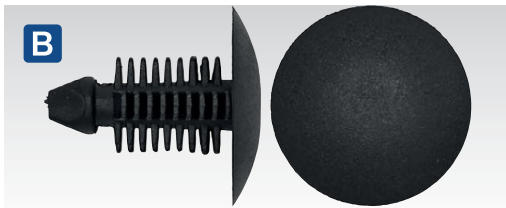

B TCFT2022U

Universal



C TCFT1830

BMW, Chrysler, Ford, GM

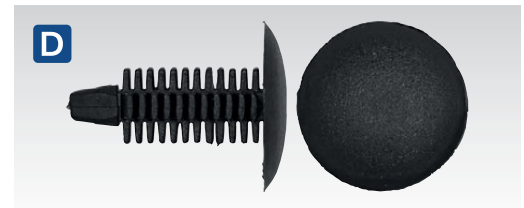

D TCFT1823U

Universal

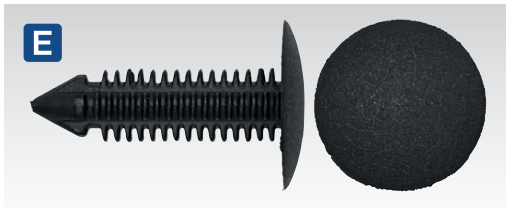

E TCFT24207U

Universal 7-7.4mm Hole

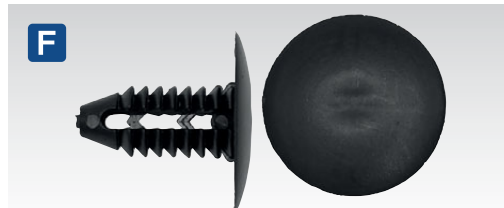

F TCFT2018U

Universal



G TCFT1820

Citroen, Ford, GM, Peugeot

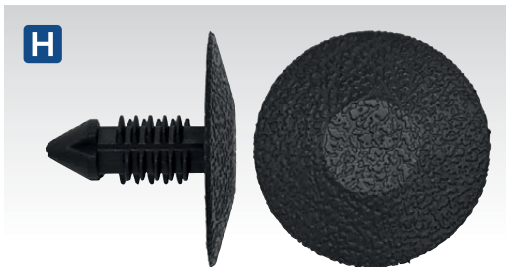

H TCFT2420U

Universal 7.2mm Hole

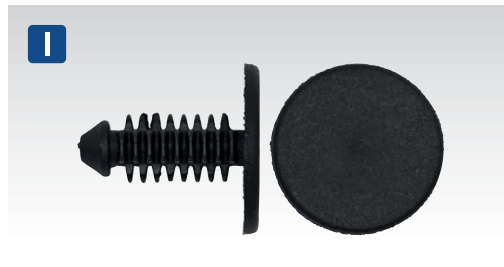

I TCFT1820P

Peugeot

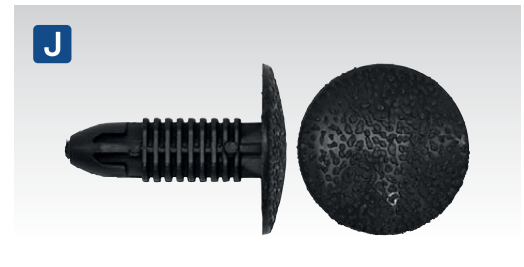

J TCFT1823

Honda, Suzuki

B-J SEE BELOW

Trim Clips

Assortment of the most common body trim clips found on the listed vehicles. Supplied in bags of 20.

Model No:	Type:	Applications:
B TCFT2022U	Fir Tree Clip, Ø21mm x 23mm	Universal
C TCFT1830	Fir Tree Clip, Ø18mm x 32mm	BMW, Chrysler, Ford, GM
D TCFT1823U	Fir Tree Clip, Ø18mm x 23mm	Universal
E TCFT24207U	Fir Tree Clip, Ø18mm x 30mm, 7-7.4mm Hole	Universal
F TCFT2018U	Fir Tree Clip, Ø19mm x 18mm	Universal

Model No:	Type:	Applications:
G TCFT1820	Fir Tree Clip, Ø18mm x 18mm	Citroen, Ford, GM, Peugeot
H TCFT2420U	Fir Tree Clip, Ø25mm x 20mm, 7.2mm Hole	Universal
I TCFT1820P	Fir Tree Clip, Ø18mm x 18mm	Peugeot
J TCFT1823	Fir Tree Clip, Ø18mm x 25mm	Honda, Suzuki

EASY-MATCH Trim Clips shown at actual size for easy identification.



A TCFT1418 GM/Citroen - Carpet/Trim



B TCPC2230VW VW - Door Trim

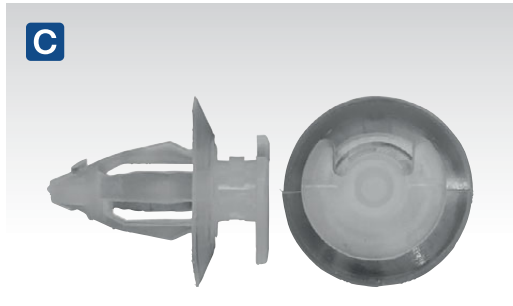

C TCPC2020VW Audi, VW



D TCPC1320 Land Rover - Door Panel

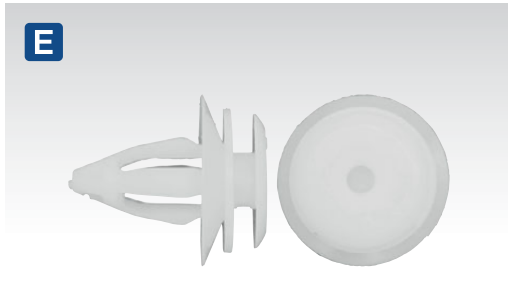

E TCPC1820 BMW, Renault - Door Trim



F TCPC1820VW VW - Door Trim

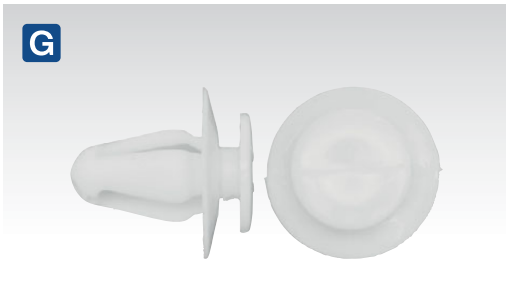

G TCPC2020 Hyundai, Suzuki, Toyota

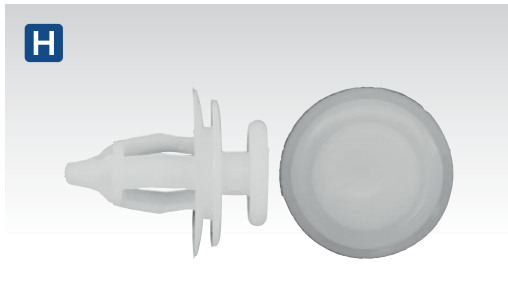

H TCPC1822U Universal - Door Trim

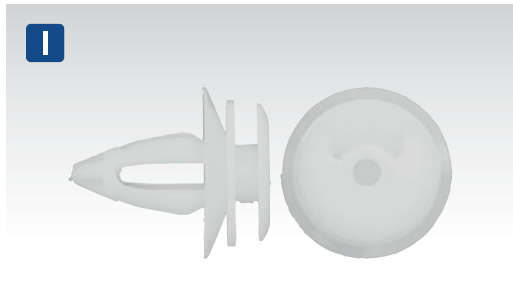

I TCDC1820U Universal - Door Trim

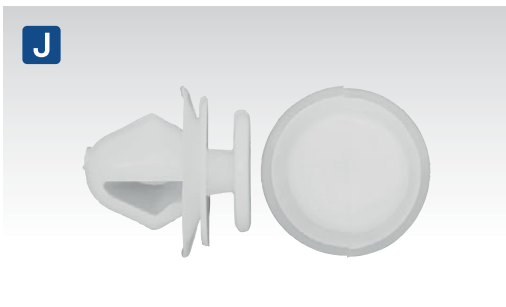

J TCPC2018 Citroen, Peugeot

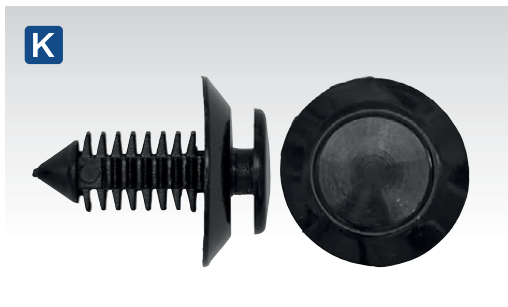

K TCPC2025 Ford



L TCPC1820B Universal - Door Trim

A-L SEE BELOW

Trim Clips

Assortment of the most common body trim clips found on the listed vehicles. Supplied in bags of 20.

Model No:	Type:	Applications:	Model No:	Type:	Applications:
A TCFT1418	Fir Tree Clip, Carpet/Trim, Ø14mm x 18mm	GM, Citroen	G TCPC2020	Panel Clip, Ø18mm x 21mm	Hyundai, Suzuki & Toyota
B TCPC2230VW	Panel Clip, Door Trim, Ø22mm x 30mm	VW	H TCPC1822U	Panel Clip, Door Trim, Ø18mm x 22mm	Universal
C TCPC2020VW	Panel Clip, Ø18mm x 21mm	Audi & VW	I TCDC1820U	Panel Clip, Door Trim, Ø18mm x 21mm	Universal
D TCPC1320	Panel Clip, Door Panel, Ø13mm x 21mm	Land Rover	J TCPC2018	Panel Clip, Ø18mm x 18mm	Citroen & Peugeot
E TCPC1820	Panel Clip, Door Trim, Ø18mm x 21mm	BMW & Renault	K TCPC2025	Panel Clip, Ø20mm x 25mm	Ford
F TCPC1820VW	Panel Clip, Door Trim, Ø18mm x 22mm	VW	L TCPC1820B	Panel Clip, Door Trim, Ø18mm x 21mm	Universal

EASY-MATCH Trim Clips shown at actual size for easy identification.



A TCPC2525 Audi, VW - 1/4 Turn **B** TCPC1815 Kia, Hyundai **C** TCPC1718 GM

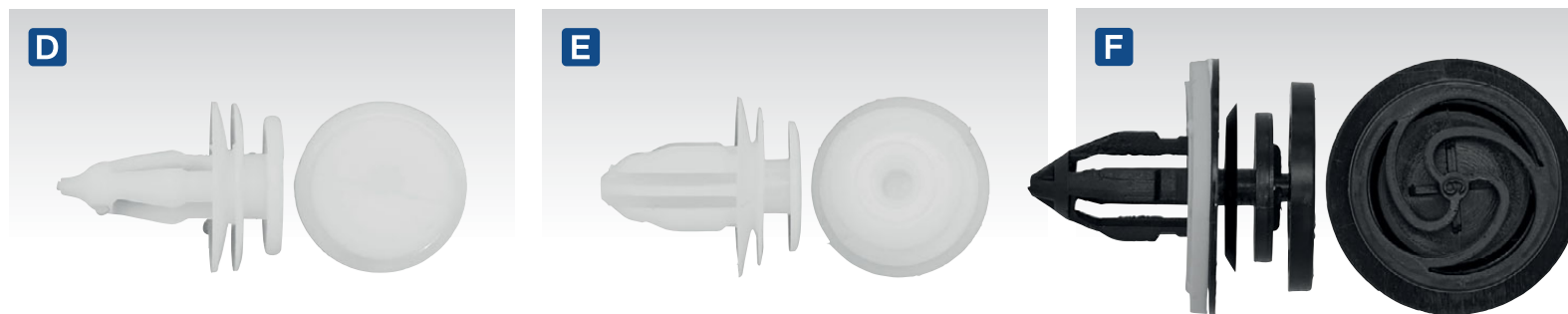

D TCPC1820U Universal - Interior Panel **E** TCPC2020U Universal - Door Trim **F** TCPC2530U Universal - Interior with Sealer



G TCRC1510U Universal **H** TCRC1210 Citroen **I** TCRC2018 Universal **J** TCLN0508 Ford, GM



K TCLN1515U Universal **L** TCLN1010U Universal **M** TCLN1520B Universal **N** TCPN1520U Universal

A-N SEE BELOW

Trim Clips

Assortment of the most common body trim clips found on the listed vehicles. Supplied in bags of 20.

Model No:	Type:	Applications:	Model No:	Type:	Applications:
A TCPC2525	Panel Clip, 1/4 Turn, Ø26mm x 26mm	Audi & VW	H TCRC1210	Retaining Clip, Ø12mm x 12mm	Citroen
B TCPC1815	Panel Clip, Ø18mm x 15mm	Kia & Hyundai	I TCRC2018	Retaining Clip, Ø20mm x 16mm	Universal
C TCPC1718	Panel Clip, Ø17mm x 18mm	GM	J TCLN0508	Locking Nut, Ø16mm x 10mm	Ford & GM
D TCPC1820U	Panel Clip, Interior Panel, Ø18mm x 21mm	Universal	K TCLN1515U	Locking Nut, Ø15mm x 15mm	Universal
E TCPC2020U	Panel Clip, Door Trim, Ø19mm x 21mm	Universal	L TCLN1010U	Locking Nut, Ø10mm x 10mm	Universal
F TCPC2530U	Panel Clip, Interior with Sealer, Ø27mm x 30mm	Universal	M TCLN1520B	Locking Nut, Ø15mm x 20mm	Universal
G TCRC1510U	Retaining Clip, Ø16mm x 11mm	Universal	N TCPN1520U	Locking Nut, Ø16mm x 20mm	Universal

EASY-MATCH Trim Clips shown at actual size for easy identification.

A **TCLN2510** Mercedes

B **TCLN2020** Toyota, Lexus

C **TCLN2020U** Universal - Wing Fixing

D **TCLN0810** VW

E **TCLN1520G** VW Golf VI

F **TCLN1812** Toyota

G **TCPR1013** Audi, BMW, VW

H **TCPR1520** Mercedes

I **TCPR1614** GM, Japanese

J **TCPR1416** GM

K **TCPR2015U** Universal

L **TCPR1614VW** Audi, VW

M **TCPR0813** BMW, VW

N **TCLN1520U** Universal - Push-In

A-N SEE BELOW

Trim Clips

Assortment of the most common body trim clips found on the listed vehicles. Supplied in bags of 20.

Model No:	Type:	Applications:	Model No:	Type:	Applications:
A TCLN2510	Locking Nut, Ø24mm x 11mm	Mercedes	H TCPR1520	Push Rivet, Ø15mm x 33mm	Mercedes
B TCLN2020	Locking Nut, Ø20mm x 20mm	Toyota & Lexus	I TCPR1614	Push Rivet, Ø16mm x 21mm	GM, Japanese
C TCLN2020U	Locking Nut, Wing Fixing, Ø20mm x 21mm	Universal	J TCPR1416	Push Rivet, Ø14mm x 24mm	GM
D TCLN0810	Insert Locking Nut, Ø8mm x 10mm	VW	K TCPR2015U	Push Rivet, Ø20mm x 30mm	Universal
E TCLN1520G	Locking Nut, Ø15mm x 22mm	VW Golf VI	L TCPR1614VW	Push Rivet, Ø16mm x 22mm	Audi & VW
F TCLN1812	Locking Nut, Ø18mm x 12mm	Toyota	M TCPR0813	Push Rivet, Ø10mm x 22mm	BMW & VW
G TCPR1013	Push Rivet, Ø10mm x 25mm	Audi, BMW & VW	N TCLN1520U	Push-In Locking Nut, Ø15mm x 21mm	Universal

EASY-MATCH Trim Clips shown at actual size for easy identification.



A TCPR2012

Ford

B TCPR1518

Volvo

C TCBC2018R

Renault - Bumper/Radiator Fixing



D TCBC2018U

Universal - Bumper/Radiator Fixing

E TCPR2020VW

Audi, Seat, VW

F TCPR3017

Toyota

G TCPR1515

BMW, GM



H TCPR2015C

Citroen

I TCPR2015J

Honda, Toyota

J TCPR1820

Honda, Mitsubishi, Toyota

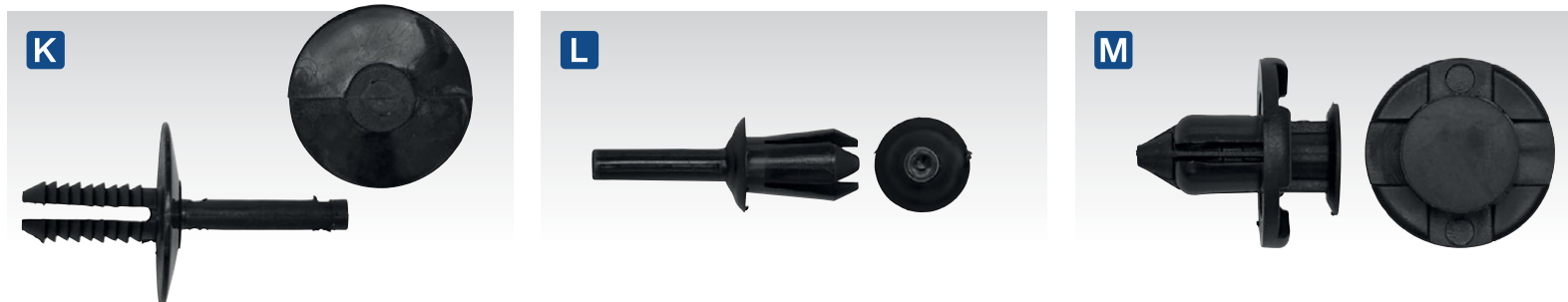

K TCPR2018BMW

BMW

L TCPR1015

Universal

M TCPR2016

Nissan

A-M SEE BELOW

Trim Clips

Assortment of the most common body trim clips found on the listed vehicles. Supplied in bags of 20.

Model No:	Type:	Applications:	Model No:	Type:	Applications:
A TCPR2012	Push Rivet, Ø17mm x 20mm	Ford	H TCPR2015C	Push Rivet, Bumper, Ø20mm x 35mm	Citroen
B TCPR1518	Push Rivet, Ø15mm x 41mm	Volvo	I TCPR2015J	Push Rivet, Ø20mm x 19mm	Honda & Toyota
C TCBC2018R	Push-in Bumper/Radiator Fixing, Ø35mm x 25mm	Renault	J TCPR1820	Push Rivet, Ø18mm x 25mm	Honda, Mitsubishi & Toyota
D TCBC2018U	Push-in Bumper Fixing Rivet, Ø20mm x 24mm	Universal	K TCPR2018BMW	Push Rivet, Bumper, Ø20mm x 36mm	BMW
E TCPR2020VW	Push Rivet, Ø20mm x 42mm	Audi, Seat & VW	L TCPR1015	Push Rivet, Ø10mm x 28mm	Universal
F TCPR3017	Push Rivet, Ø17mm x 39mm	Toyota	M TCPR2016	Push Rivet, Ø20mm x 22mm	Nissan
G TCPR1515	Push Rivet, Ø15mm x 24mm	BMW & GM			

EASY-MATCH Trim Clips shown at actual size for easy identification.

		
<p>A TCPR2020GM GM</p>	<p>B TCBC1522 GM - Bumper Fixing Rivet</p>	<p>C TCPR1014U Universal</p>
		
<p>D TCBT3525U GM - Bumper Fixing Rivet</p>	<p>E TCPR1518U Universal - 6.3mm Hole</p>	<p>F TCPR1730U Universal</p>
		
<p>G TCPR2015 Universal</p>	<p>H TCMC1413 Citroen C4</p>	<p>I TCMC2018 Citroen, Fiat, Peugeot</p>
		
<p>J TCMC1820VW VW Golf III - Clip/Grommet</p>	<p>K TCMC2016 Peugeot</p>	<p>L TCMC1805U Universal</p>

A-L SEE BELOW

Trim Clips

Assortment of the most common body trim clips found on the listed vehicles. Supplied in bags of 20.

Model No:	Type:	Applications:	Model No:	Type:	Applications:
A TCPR2020GM	Push Rivet, Ø20mm x 25mm	GM	G TCPR2015	Push Rivet, Ø20mm x 20mm	Universal
B TCBC1522	Push-in Bumper Fixing Rivet, Ø15mm x 37mm	GM	H TCMC1413	Side Moulding Clip, Ø20mm x 18mm	Citroen C4
C TCPR1014U	Push Rivet, Ø10mm x 22mm	Universal	I TCMC2018	Moulding Clip, Ø20mm x 19mm	Citroen, Fiat & Peugeot
D TCBT3525U	Push-in Bumper Fixing Rivet, Ø20mm x 36mm	GM	J TCMC1820VW	Side Moulding Clip/Grommet, Ø18mm x 23mm	VW Golf III
E TCPR1518U	Push Rivet, Ø15mm x 55mm, 6.3mm Hole	Universal	K TCMC2016	Moulding Clip, Ø20mm x 17mm	Peugeot
F TCPR1730U	Push Rivet, Ø15mm x 36mm	Universal	L TCMC1805U	Side Moulding Clip, 18mm x 14mm	Universal

EASY-MATCH Trim Clips shown at actual size for easy identification.

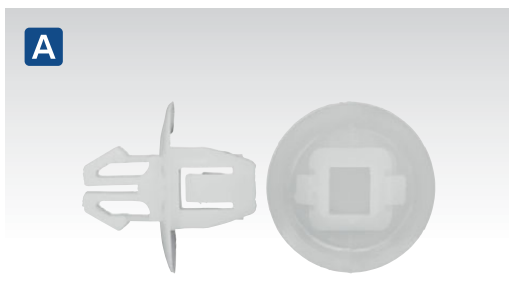

A TCMC1820

Suzuki, Toyota

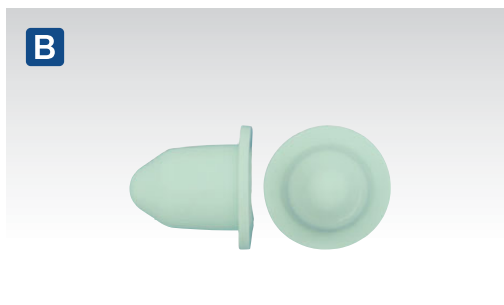

B TCMC2018G

Peugeot

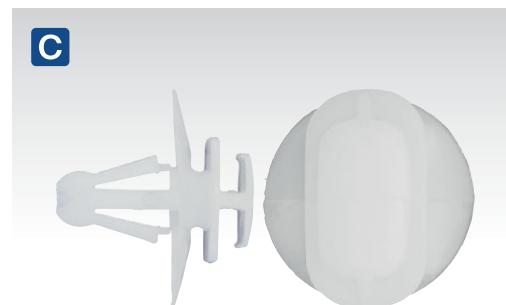

C TCMC2222U

Universal



D TCBT2528U

Universal

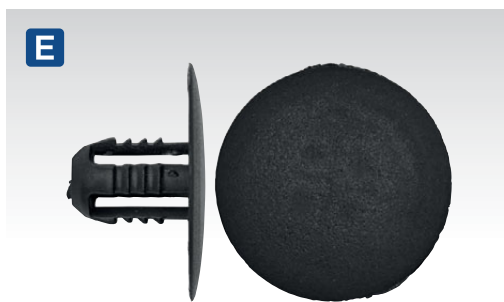

E TCBT2515U

Universal



F TCBT3020U

Universal



G TCSR1520

Ford

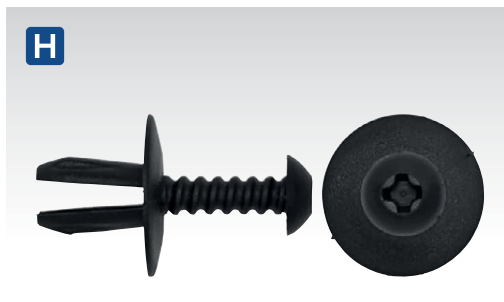

H TCSR1712U

Universal

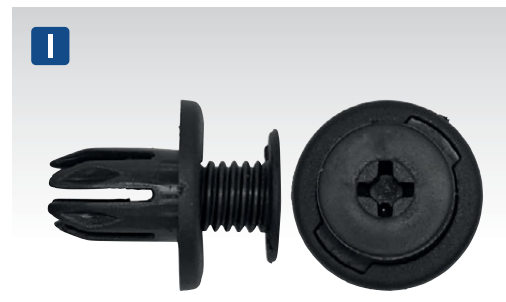

I TCSR2015J

Japanese



J TCSR1813

Toyota



K TCSR1525

Ford, GM - Bumper



L TCSR1525U

Universal

A-L SEE BELOW
Trim Clips

Assortment of the most common body trim clips found on the listed vehicles. Supplied in bags of 20.

Model No:	Type:	Applications:	Model No:	Type:	Applications:
A TCMC1820	Side Moulding Clip, Ø18mm x 19mm	Suzuki & Toyota	G TCSR1520	Screw Rivet, Ø15mm x 30mm	Ford
B TCMC2018G	Moulding Clip, Ø13mm x 12mm	Peugeot	H TCSR1712U	Screw Rivet, Ø17mm x 28mm	Universal
C TCMC2222U	Side Moulding Clip, Ø23mm x 20mm	Universal	I TCSR2015J	Screw Rivet, Ø20mm x 25mm	Japanese
D TCBT2528U	Under Bonnet Insulation Fixing Clip, Ø25mm x 30mm	Universal	J TCSR1813	Screw Rivet, Ø19mm x 21mm	Toyota
E TCBT2515U	Under Bonnet Insulation Fixing Clip, Ø25mm x 15mm	Universal	K TCSR1525	Screw Rivet, Bumper, Ø15mm x 33mm	Ford, GM
F TCBT3020U	Under Bonnet Insulation Fixing Clip, Ø31mm x 19mm	Universal	L TCSR1525U	Screw Rivet, Ø15mm x 34mm	Universal

EASY-MATCH Trim Clips shown at actual size for easy identification.



A TCSR1825U

Universal

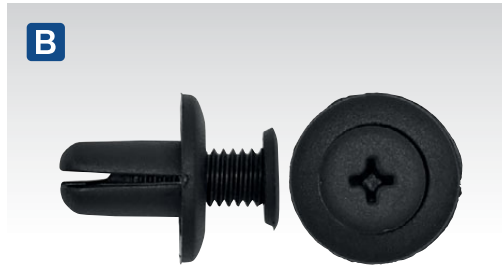

B TCSR1815

Ford, Hyundai, Kia, Mazda



C TCSR1514

GM, Honda



D TCSR2012

Mazda



E TCSR2023

Ford, Kia, Mazda, Nissan

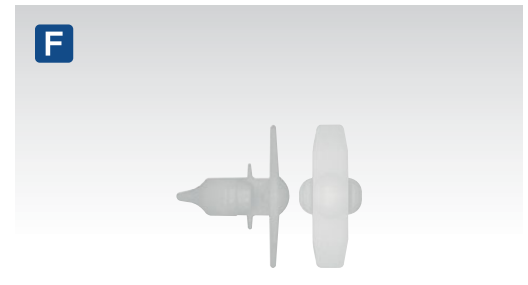

F TCWS1512

VAG



G TCWS1213

Toyota

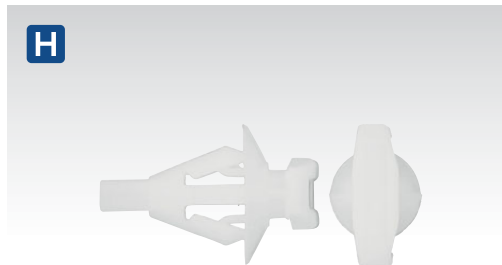

H TCWS1414

Hyundai

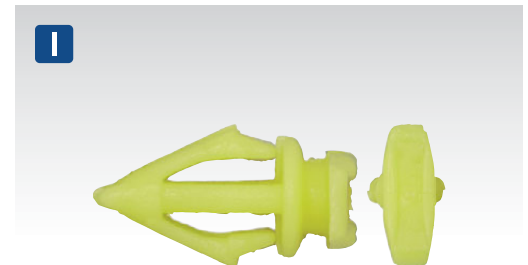

I TCWS1515

Hyundai



J TCWS1810

VW

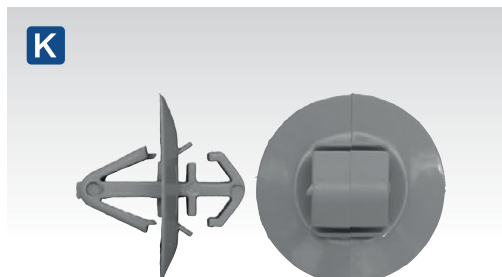

K TCPC2016

GM, Nissan, Renault

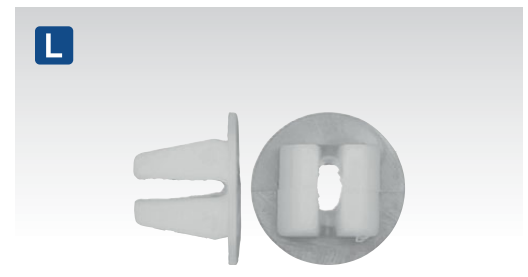

L TCLN1612U

Universal

A-L SEE BELOW

Trim Clips

Assortment of the most common body trim clips found on the listed vehicles. Supplied in bags of 20.

Model No:	Type:	Applications:	Model No:	Type:	Applications:
A TCSR1825U	Screw Rivet, Ø18mm x 35mm	Universal	G TCWS1213	Weatherstrip Clip, Ø12mm x 12mm	Toyota
B TCSR1815	Screw Rivet, Ø18mm x 24mm	Ford, Hyundai, Kia & Mazda	H TCWS1414	Door Weatherstrip Clip, 15mm x 15mm	Hyundai
C TCSR1514	Screw Rivet, Ø15mm x 21mm	GM & Honda	I TCWS1515	Weatherstrip Clip, 15mm x 14mm	Hyundai
D TCSR2012	Screw Rivet, Ø20mm x 23mm	Mazda	J TCWS1810	Weatherstrip Clip, 18mm x 10mm	VW
E TCSR2023	Screw Rivet, Ø20mm x 30mm	Ford, Kia, Mazda & Nissan	K TCPC2016	Panel/Moulding Clip, Ø20mm x 18mm	GM, Nissan & Renault
F TCWS1512	Weatherstrip Clip, 15mm x 12mm	VAG	L TCLN1612U	Captive Nut, Ø16mm x 12mm	Universal



A SCSG06
Premier Pressure Industrial HC Sprayer with Viton® Seals

Premium quality 1L hand pump sprayer. Manufactured for use with most oils, weed killers, brake cleaners and solvents. Viton® seals allow use with a wide range of semi volatile chemicals that would deteriorate standard seals. Safety valve with depressurization option. Large 60mm opening for easy refilling and reduced spillage. Translucent tank allows easy measurement of contents using the side level indicator. Supplied with adjustable 'cone' nozzle, allowing easy and precise application of liquid. Robust composite construction, with ergonomic pump and handle.

	Working Capacity: 1L
	Total Capacity: 1.5L



B SCSG07
Premier Pressure Industrial Detergent Sprayer

Premium quality 1L hand pump sprayer. Manufactured for use with detergents, and acids. Safety valve with depressurization option. Large 60mm opening for easy refilling and reduced spillage. Translucent tank allows easy measurement of contents using the side level indicator. Supplied with adjustable 'cone' as well as standard 'fan' nozzles, allowing easy and precise application of liquid. Can fit other types of nozzles. Robust composite construction, with ergonomic pump and handle.

	Working Capacity: 1L
	Total Capacity: 1.5L



C SCSG2R
2L Rechargeable Pressure Sprayer

Suitable for use with most detergents, pesticides and non solvent based fluids. Convenient screw top for storing the USB charging cable. Adjustable nozzle can create mist and jet spray patterns. 110 Minutes continuous use run time. 210 Minutes charge time via USB.

Working Capacity:	2L
Total Capacity:	2.2L



D SCSG08
Premier Pressure Industrial Foam Sprayer

Premium quality hand pump foam sprayer manufactured specifically for the generation of dry and long lasting foam. Ideal for cleaning and disinfecting bathrooms, changing rooms, kitchens and food processing stations. Also suitable for upholstery and carpets, disinfecting, car washes etc. For use with chemical agents with surfactant properties. Provides a dense and durable foam, Safety valve with depressurization option. Large 60mm opening for easy refilling and reduced spillage. Translucent tank with level indicators. Supplied with three mixers which vary the ratio of air to cleaning fluid in the foam generation. Robust composite construction with ergonomic pump and handle.

	Working Capacity: 0.75L
	Total Capacity: 1.5L



E-F SEE BELOW
Pressure Solvent Sprayers with Viton® Seals

Suitable for use with most brake cleaners, detergents, traffic film removers, penetrating oils and weed killers. Adjustable nozzle enables a mist to jet pattern, which allows an easy and direct application of liquid exactly where it is required. Robust composite construction.

Model No:	Capacity:
E SCSG02	1L
F SCSG03	1.5L



G-H SEE BELOW
Premium Pressure Solvent Sprayers with Viton® Seals

Premium quality hand pump sprayers. Suitable for use with most brake cleaners, detergents, traffic film removers, penetrating oils and weedkillers. Adjustable nozzle enables a mist to jet pattern, which allows an easy and direct application of liquid exactly where it is required. Robust composite construction.

Model No:	Capacity:
G SCSG04	1L
H SCSG05	1.5L



Viton® seals have excellent mechanical, heat and chemical compatibility properties. They work well with acids, oils, ozone, fuels and Alkaline, covering a very wide range of products.



I SCSGRK
Viton® Seal Kit for SCSG02 & SCSG03
Viton® seal kit for Model No's SCSG02 and SCSG03 Pressure Hand Sprayers.

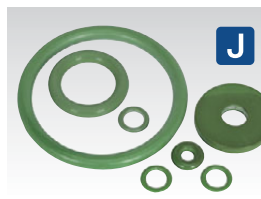

J SCSGPRK
Viton® Seal Kit for SCSG04 & SCSG05
Viton® seal kit for Model No's SCSG04 and SCSG05 Pressure Hand Sprayers.

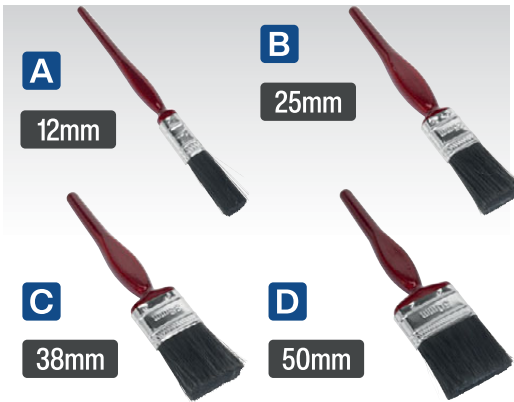

A-D SEE BELOW

Pure Bristle Paint Brushes - Packs of 10

Square cut ends, held by chrome ferrules. Painted composite handles.

Model No:	Size (Metric):	Size (Imperial):
A SPB12S	12mm	1/2"
B SPB25S	25mm	1"
C SPB38S	38mm	1-1/2"
D SPB50S	50mm	2"



E SPBS3

3pc Pure Bristle Paint Brush Set

Pure bristles with square cut ends, held by chrome ferrules. Painted composite handles.

Size (Metric):	25, 38, 50mm (1 of each)
Size (Imperial):	1", 1-1/2", 2"
Quantity:	3



F SPBS9

9pc Pure Bristle Paint Brush Set

Pure bristles with square cut ends, held by chrome ferrules. Painted composite handles.

Size (Metric):	12 (x1), 25 (x3), 38 (x3), 50mm (x2)
Size (Imperial):	1/2", 1", 1-1/2", 2"
Quantity:	9



G-H SEE BELOW

Wooden Handle Paint Brushes

Holds high volume of paint suitable for covering large areas. Epoxy resin glue holds bristles securely. Stainless steel ferrule prevents rusting. Suitable for use with most oil and water based paints. Smooth wooden handle for maximum user comfort.

Model No:	Size:
G SPBS76W	76mm/3"
H SPBS100W	100mm/4"



I SPBS3W

3pc Wooden Handle Paint Brush Set

Synthetic filaments, giving a very smooth finish with all paints. Optimal paint pick-up and spread, provides excellent control.

Size (Metric):	25mm, 38mm, 50mm (1 of each)
Size (Imperial):	1", 1-1/2", 2"
Quantity:	3



J SPBS5W

5pc Wooden Handle Paint Brush Set

Synthetic filaments, giving a very smooth finish with all paints. Optimal paint pick-up and spread provides excellent control.

Size (Metric):	25mm (x2), 38mm (x2), 50mm
Size (Imperial):	1" (x2), 1-1/2" (x2), 2"
Quantity:	5



K-L SEE BELOW

Round Sash Brushes

Ideal for profiled surfaces and detail work such as window frames, architrave, mouldings and more. Epoxy resin glue holds bristles securely. Chisel tip allows for precise cutting in. Stainless steel prevents ferrule from rusting. Smooth wooden handle designed for maximum user comfort.

Model No:	Size:
K SPBS15R	15mm
L SPBS21R	21mm



M SPBR50

50mm Wooden Handle Radiator Paint Brush

Radiator brush with angled head for easy access. Suitable for all paints. Heat treated synthetic filaments to ensure a high quality finish. Polished beech handle with a stainless steel ferrule.

Size (Metric):	50mm
Size (Imperial):	2"



N SPBA50

50mm Wooden Handle Cutting In Paint Brush

Tapered bristles ideal for cutting in. Suitable for all paints. Heat treated synthetic filaments to ensure a high quality finish. Polished beech handle. Stainless steel ferrule.

Size (Metric):	50mm
Size (Imperial):	2"



O PB2

10pc Wooden Handled Touch-Up Paint Brush Assortment

Assorted pack of touch-up brushes with wooden handles.

Length:	180-200mm
Pack Quantity:	10

A-B SEE BELOW

Concentrated General-Purpose TFR Detergents with Wax

Formulated with a specific blend of detergents and sequestrants to remove traffic film, oil, grease and all general soiling found on vehicles. Includes rinse aid and wax to assist with the final stage of cleaning. Biodegradable and additional inhibitor prevents scale build-up and corrosion in pressure washer.

Model No:	Size:
A SCS003	5L
B SCS004	25L



C-D SEE BELOW

Concentrated Premium TFR Detergents with Wax

The unique blend of high quality detergents and surfactants give optimum performance when cleaning vehicles, reducing the need for agitation. Easily, gently and rapidly lifts dirt, grime and oil from vehicle paintwork. Incorporates a sophisticated wax and rinse aid system to give shine and protection to paintwork.

Model No:	Size:
C SCS001	5L
D SCS002	25L



E SCS005

5L Car Shampoo with Wax

Added shine enhancer and paint protector.



F SCS006

5L Premium Car Shampoo with Wax

Concentrated premium quality car shampoo, a special high active formulation with added carnauba wax blend to give protection and exceptional cleaning which enhances the appearance of vehicle paintwork. Will help to protect paint and create a bead affect.



G SCS007

5L Patio Cleaner

Non-corrosive chlorine-free patio cleaner. For the safe and effective removal of algae, moss and fungi from walls, paths, roofs, patios and other hard surfaces.



H SCS009

5L Heavy-Duty Wheel Cleaner

Heavy-duty alkaline (non-acidic) concentrated formula ideal for removing brake dust and general wheel grime. Especially suitable for alloy wheels. Dilute ten parts water to one part wheel cleaner. Recommended to be applied with low pressure sprayer, then rinsed off with higher water pressure after allowing a few minutes for solution to activate.



I SCS090

5L Snow Foam Car Shampoo

The ultimate high snow foaming traffic film removal solution. This thick rich cleaning snow foam will allow longer dwell time to break down dirt and soiling. Non-wax stripping, PH neutral, easy rinse for a streak-free finish. Perfect for car detailing, suitable for all paint surfaces including ceramic coated.



J SEE BELOW

Carpet/Upholstery Detergent

These chemical agents are specially formulated for use in Sealey valeting systems and provide powerful, non-corrosive cleaning power.

Model No:	Size:	Pack Qty:
VMR921S	1L	1
VMR921	1L	10
VMR925S	5L	1
VMR925	5L	4

ALWAYS CHECK THE DILUTION RATES

When purchasing any of the products featured on this page, it is important to check the dilution rates to see exactly how much fluid you will be getting from each full container. All of our cleaning products A-J are made in the UK and come with impressive dilution rates meaning you get more for your money than some others available on the market.

All TFR detergents are available as **5L** or **25L**

	A	B	C	D	E	F
Model No:	SCS003	SCS004	SCS001	SCS002	SCS005	SCS006
Max. Dilution Rate:	200:1 = 1000L	200:1 = 5000L	300:1 = 1500L	300:1 = 7500L	500:1 = 2500L	200:1 = 1000L
	G	J	J	J	J	J
Model No:	SCS007	VMR921S	VMR921	VMR925S	VMR925	VMR925
Max. Dilution Rate:	10:1 = 50L	80:1 = 80L	80:1 = 800L	80:1 = 400L	80:1 = 1600L	



A SEE BELOW

Emulsifiable Degreasing Solvent

High quality, general purpose, low odour cleaning solvent. Contains emulsifiers which enable it to form an emulsion with water, aiding cleaning of solvent from workpiece. Also suitable for engine cleaning.

Model No:	Size:
AK05	5L
AK25	25L



B SEE BELOW

Degreasing Solvent

Suitable for use in Sealey and other leading makes of parts cleaning tank.

Model No:	Size:
AK2001	20L
AK2501	25L



C SEE BELOW

Ultrasonic Cleaning Fluid

Specialist solution for use in ultrasonic cleaners. Safely removes dirt, grease and oil. To eliminate risk, a sample should be used to test the suitability of the product. Always be sure to dilute solution to the required strength.

Model No:	Size:
SCT5D	5L
SCT25D	25L



D SCS201

500ml Rust Remover

Can be used on cars, motorcycles, caravans, boats, agricultural equipment and machinery.

Size:	500ml
-------	-------



E SEE BELOW

150ml Air Conditioning Refresher

Air conditioning refresher with an apple fresh fragrance, eliminates odours from air-con and heating systems, leaving the system clean and free of germs.

Model No:	Pack Qty:
SCS023	6
SCS023S	1



F DPFCA400

DPF Catalyst Cleaner

This DPF/Catalyst Cleaner is usable for all closed particulate filter systems. It is designed to dissolve and remove all contamination and soot residues from the diesel particulate filter and the catalyst. The removal of the DPF is not required. It is also ideal for EGR cleaning and evaporates residue-free. Sufficient for one application.

Size:	400ml
-------	-------



G DPFPC375

Diesel Particulate Filter Cleaner

Diesel fuel additive solution, high power cleaner suitable for diesel engine vehicles fitted with a diesel particle filter. Ensures complete filter cleaning while driving. The product can be used in all diesel engines and mixed with all diesel fuels. This 375ml can is sufficient for 60 to 80L of diesel fuel, simply add to the fuel tank before filling up.

Size:	375ml
-------	-------



H FSCD300

Fuel System Cleaner - Diesel Engines

For use in diesel powered vehicles, designed to remove resin deposits, prevent the oxidation of fuel and the growth of micro-organisms. Lubricates and protects the diesel injection system and the upper cylinder area. Suitable for all diesel engines including those fitted with a particle filter, turbocharger and catalytic converter. Pour directly into the fuel tank when refuelling, one 300ml can treats 80L of diesel fuel.

Size:	300ml
-------	-------



I FSCP300

Fuel System Cleaner Petrol Engines

High performance fuel system cleaner for all petrol engines. Removes varnish and gum deposits from the entire fuel system. One can sufficient for 60 to 80L of petrol, add to the fuel tank before refuelling.

Size:	300ml
-------	-------



J OSCL300

Oil System Cleaner Petrol & Diesel Engines

High performance cleaner for all petrol and diesel engines. Can also be used in gearboxes and differentials. Removes sludge and contamination from internal surfaces. Treats up to 6L of oil.

Size:	300ml
-------	-------



K CCOS300

Oxygen Sensor Catalytic Converter Cleaner

High capacity cleaner designed to dissolve dirt, varnish and carbon residue throughout the exhaust system. The primary function is to clean the oxygen sensor and catalytic converter to optimise performance. Suitable for use in petrol and diesel vehicles. Treats 60 to 80L of fuel.

Size:	300ml
-------	-------

A NEW



A TOL40

Plain White Toilet Roll - Pack of 40

Embossed 2-ply soft white toilet rolls. Wrapped in sleeves of 4 rolls.

Ply:	2
Type:	Embossed
Width:	420mm
Sheets on Roll:	320
Pack Quantity:	10 Packs of 4 (40 Rolls)

B



B WHT150

150m White Embossed 2-Ply Paper Roll - Pack of 6

Pack of six white embossed paper, centre-feed, 2-ply, perforated roll wipes.

Ply:	2
Type:	Embossed
Width:	175mm
Length:	150m
Pack Quantity:	6

C



C BLU150

150m Blue Embossed 2-Ply Paper Roll - Pack of 6

Pack of six blue embossed paper, centre-feed, 2-ply, perforated roll wipes.

Ply:	2
Type:	Embossed
Width:	190mm
Length:	150m
Pack Quantity:	6

D



D SCP1501

73gsm Multipurpose Paper Wipes in Dispenser Box Smooth White - 150 Sheets

Strong, durable and tear resistant. Absorbs liquids fast and up to four times its own mass. Rinse and reuse over and over again. Low-linting. Solvent and chemical resistant. Use both wet and dry.

Sheets Per Pack:	150
Weight:	73gsm

E



E SCP1601

69gsm Multipurpose Paper Wipes in Dispenser Box Creped Turquoise - 160 Sheets

Strong, durable and tear resistant. Absorbs liquid up to four times its own mass. Rinse and reuse over and over again. Low-linting. Solvent and chemical resistant. Use both wet and dry. Embossed to ensure effective dirt pick-up.

Sheets Per Pack:	160
Weight:	69gsm

F



F CCSET550

5-in-1 Disposable Car Interior Protection Kit - Display Box of 50

Kit includes PE backed floor mat, disposable seat, steering wheel, handbrake and gear lever covers. Ideal for protecting the vehicle's interior from dirt, grease and oil whilst servicing, valeting or when bodyshop work is undertaken. Suitable for most cars and light commercial vehicles.

Contents:	
Floor Mat - 80g + PE 15g:	500 x 380mm
Seat Cover - 13micron:	130 x 80mm
Steering Wheel Cover - 20micron:	100 x 130mm
Gear Lever Cover - 20micron:	140 x 145mm
Hand Brake Cover - 20micron:	90 x 170mm



G



H



G SWPH150

150m Steering Wheel Protection Film with Applicator Handle

Comfort grip handle for easy and fast application. 150m x 125mm Film.

H SWPF150

150m Steering Wheel Protection Film

150m x 125mm Film.



A SCW3
Hand Wipes Bucket - Pack of 150
 Durable, extra-large wipes for removing a variety of tough substances including oil and grease. Moisture locked wipes means no need for water. Supplied in a dispensing bucket containing 150 wipes.



B SSW80
Heavy-Duty Hand Wipes Textured - Pack of 80
 Heavy-duty textured hand wipes. Ideal for removing dirt, oil, grease, grime and non-cured petroleum based contaminants. Antimicrobial properties leave hands hygienically clean.



C SCS045S
500ml Multipurpose Foam Cleaner
 Suitable for use on upholstery, glass, ceramics, laminates, PVC, office furniture and work surface areas. Immediate foaming action lifts grime. Wipes away easily and doesn't drip or run.



D SEE BELOW
Polypropylene Rope
 Multipurpose heavy-duty weather resistant polypropylene rope. Available in Ø8mm and Ø10mm, in 220m lengths.

Model No:	Diameter:	Length:
RC08220	Ø8mm	220m
RC10220	Ø10mm	220m



E-F SEE BELOW
Hand Cleaner Lemon Zing
 Fast, effective hand cleaner for removal of oil, grease, dirt and other ground-in soils. Based on natural citrus extracts, contains perlite particles for deep cleaning and lanolin helps to prevent chapped and dry hands. Solvent-free, contains Aloe Vera with antibacterial properties for cuts and grazes. Ideal for use in garages, workshops, factories and engineering shops. Model No. SHC500 is supplied in 500ml screw top tub and Model No. SHC5L in 5L container with dispensing pump.

Model No:	Size:
E SHC500	500ml
F SHC5L	5L



G SHC05L
5L Heavy-Duty Hand Cleaner Orange Gel
 Fast, effective heavy-duty hand cleaner for removal of oil, grease, dirt and other ground-in soils. Based on natural citrus extracts, contains perlite particles for deep cleaning and lanolin to moisturise and help prevent chapped and dry hands. Solvent-free, contains Aloe Vera with antibacterial properties for cuts and grazes. Ideal for use in garages, workshops, factories and engineering shops. Supplied in 5L container with dispensing pump.

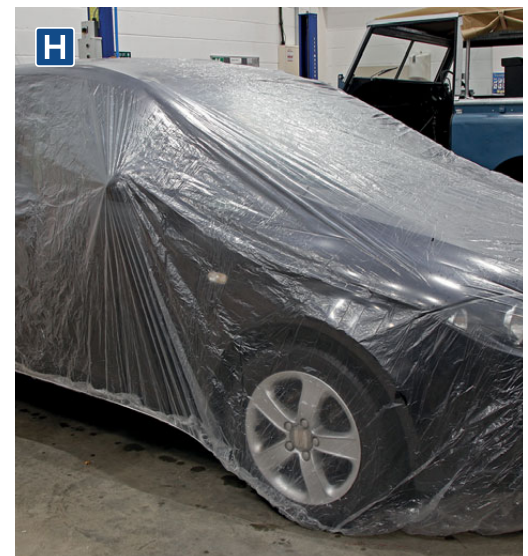

H SEE BELOW
Universal Disposable Car Covers
 Disposable full car covers with an elastic hem suitable for a wide range of vehicles. Protects a completed vehicle from scratches, overspray and dust. Ideal for bodyshops, car valeters or garages.

Model No:	Size:	Dimensions (W x D):
TDCCM	Medium	3800 x 6600mm
TDCCCL	Large	4800 x 7500mm



I SCS903
Alloy Wheel Repair Kit
 Permanently repairs curb damage, scratches, slight dents and sanding marks on alloy, composite and steel rims as well as hubcaps. Kit includes everything required to repair damage simply and quickly.



J SCS901
Windscreen Repair Kit
 Simple step-by-step process and a 30 minute curing time. Pressurising applicator penetrates deep inside chips and cracks to give an almost invisible repair. Tough resin formula fills damaged area to prevent from spreading, avoiding costly windscreen replacement. Suitable for screen chips up to Ø25mm and cracks up to 300mm long. Curing process can be sped up by using a UV lamp (not included). Improves visibility and safety.

Contents:
Push Pin, Clean Cloth, Adhesive Seal (x3), Black O-Ring (x2), Pedestal, Razor Blade, Repair Resin, Injector, Curing Film (x5)



A SB974N4
Ceramic Sand Gun Blasting Nozzles
 Ceramic sand gun blasting nozzles suitable for Model No's. SB994 and SB995 Shot Blasting Kits. Pack of 4.
Nozzle Sizes: 5mm, 6mm (x2), 7mm



B SG10/SAND6
Shot Blasting Sand - Pack of 6
 Suitable for Sealey and other recirculating shot blasters. Complies with COSHH SI-1657-1988. Not suitable for use in shot blasting cabinets.
Weight: 6 x 700g
Container: Bottle



C SG10E
Air Recirculating Sandblasting Kit
 Suitable for use in the bodyshop. The feathering action makes this blaster ideal for treating stone chips. Supplied with a set of four rubber nozzles for sealing the gun head to the panel and a 700g bottle of blasting grit. Replacement nozzles are available.
Operating Pressure: 60-120psi
Air Consumption: 5-10cfm



D SEE BELOW
25kg Shot Blasting Grit
 Suitable for both handheld and recirculating shot blasters. Complies with COSHH SI-1657-1988. Not suitable for use in shot blasting cabinets.

Model No:	Weight:	Size:	Container:
B/25KG	25kg	200-700microns	Bag
BGT25KG	25kg	200-700microns	Tub



E SEE BELOW
Shot Blasting Beads - Glass
 Beads suitable for use in shot blasting cabinets.

Model No:	Weight:	Size:	Container:
B5KG	5kg	180-300microns	Tub
GB25KG	25kg	180-300microns	Tub



F SEE BELOW
25kg Blasting Soda
 Blasting soda for use in conjunction with Sealey Model No's SB99.KIT, PSB10, PSB40 and other brands of soda blasters. Soda blasting is especially suitable for classic car restoration, when removing paint and rust, as soda will not etch glass and will not warp or remove metalwork. Surface will be left smooth. Soda also leaves a rust inhibitor behind for up to six weeks. Also suitable for a number of other applications, including removal of graffiti, mould, and grease from surfaces such as fibreglass, brick, stone, marble, tiles, glass, rubber and bearings.

Model No:	Weight:	Size:	Container:
SBG25KG	25kg	285microns	Bag
BSBG25KG	25kg	285microns	Tub



G SB993
Portable Shot Blasting Kit
 For full details, see page 737.



H SB974
Shot Blasting Cabinet - Double Access
 For full details, see page 739.



I SBKITA
Shot & Soda Blasting Kit
 For full details, see page 738.



**CHOOSE FROM
OVER 100 CASTORS
ACROSS OUR TRADE &
INDUSTRIAL RANGES.**

TRADE RANGE

Our trade range of castors on pages 1141 to 1143 are available in a variety of styles and sizes and are all backed with a 1 Year guarantee.

**1 YEAR
GUARANTEE***

INDUSTRIAL RANGE

Our industrial range of castors on pages 1144 to 1145 offer superior quality and higher load bearing capacities, backed with a 2 Year guarantee.

**2 YEAR
GUARANTEE***

RANGE AVAILABILITY

Our full range of castor wheels covers a wide variety of applications with wheel diameter sizes ranging from Ø50mm to Ø200mm and load capacities from 25kg to 600kg. See illustrations (right) for fixing and style options.



A-S Ø50mm Ø75mm Ø100mm Ø125mm 25kg 50kg 80kg 100kg

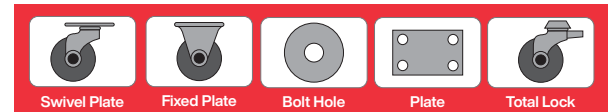

A-S SEE BELOW

Medium-Duty Rubber/Polypropylene Castor Wheels - Trade

Durable rubber/polypropylene wheels with a steel centre.

Model No	Fixing Type	Wheel Diameter	Load Capacity	Overall Height	Offset Size	Plate Size	Plate Hole Diameter	Tread Width	Swivel	Total Lock
A SCW150SB	Bolt Hole	Ø50mm	25kg	68mm	n/a	n/a	n/a	18mm	✓	✗
B SCW175SB	Bolt Hole	Ø75mm	50kg	98mm	28mm	n/a	n/a	23mm	✓	✗
C SCW1100SB	Bolt Hole	Ø100mm	80kg	131.5mm	34mm	n/a	n/a	27mm	✓	✗
D SCW1125SB	Bolt Hole	Ø125mm	100kg	154.5mm	35mm	n/a	n/a	27mm	✓	✗
E SCW150FP	Fixed Plate	Ø50mm	25kg	69.5mm	n/a	60 x 60mm	Ø13 x 6.3mm	18mm	✗	✗
F SCW175FP	Fixed Plate	Ø75mm	50kg	100mm	n/a	60 x 60mm	Ø13 x 6.3mm	23mm	✗	✗
G SCW1100FP	Fixed Plate	Ø100mm	80kg	134mm	n/a	76 x 76mm	Ø15.5 x 8.5mm	27mm	✗	✗
H SCW1125FP	Fixed Plate	Ø125mm	100kg	157mm	n/a	76 x 76mm	Ø15.5 x 8.5mm	27mm	✗	✗
I SCW150SBL	Bolt Hole	Ø50mm	25kg	68mm	n/a	n/a	n/a	18mm	✓	✓
J SCW175SBL	Bolt Hole	Ø75mm	50kg	98mm	28mm	n/a	n/a	23mm	✓	✓
K SCW1100SBL	Bolt Hole	Ø100mm	80kg	131.5mm	36.5mm	n/a	n/a	27mm	✓	✓
L SCW1125SBL	Bolt Hole	Ø125mm	100kg	154.5mm	35.5mm	n/a	n/a	27mm	✓	✓
M SCW150SP	Swivel Plate	Ø50mm	25kg	69.5mm	n/a	60 x 50mm	Ø13 x 6.3mm/12 x 6.3mm	18mm	✓	✗
N SCW175SP	Swivel Plate	Ø75mm	50kg	100mm	n/a	65 x 60mm	Ø13 x 6.3mm/12 x 6.3mm	23mm	✓	✗
O SCW1100SP	Swivel Plate	Ø100mm	80kg	134mm	n/a	76 x 76mm	Ø15.5 x 8.2mm	27mm	✓	✗
P SCW1125SP	Swivel Plate	Ø125mm	100kg	157mm	n/a	76 x 76mm	Ø15.5 x 8.2mm	27mm	✓	✗
Q SCW150SPL	Swivel Plate	Ø50mm	25kg	69.5mm	n/a	60 x 50mm	Ø13 x 6.3mm/12 x 6.3mm	18mm	✓	✓
R SCW1100SPL	Swivel Plate	Ø100mm	80kg	134mm	n/a	76 x 76mm	Ø15.5 x 8.2mm	27mm	✓	✓
S SCW1125SPL	Swivel Plate	Ø125mm	100kg	157mm	28mm	76 x 76mm	Ø76 x 76mm	27mm	✓	✓

A-L Ø50mm Ø75mm Ø100mm 40kg 60kg 90kg

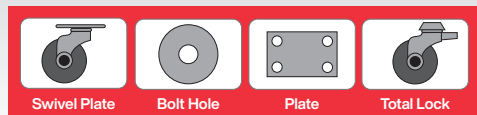

A-L SEE BELOW

Medium-Duty Thermoplastic Rubber Castor Wheels - Trade

Non-marking thermoplastic wheels with polypropylene core and plain bearing.

Model No.	Fixing Type	Wheel Diameter	Load Capacity	Overall Height	Offset Size	Plate Size	Plate Hole Diameter	Tread Width	Swivel	Total Lock
A SCW250SBEM	Bolt Hole	Ø50mm	40kg	68mm	24mm	n/a	Ø10.5mm	20mm	✓	✗
B SCW275SBEM	Bolt Hole	Ø75mm	60kg	98mm	28mm	n/a	Ø10.5mm	25mm	✓	✗
C SCW2100SBEM	Bolt Hole	Ø100mm	90kg	131.5mm	37mm	n/a	Ø10.5mm	27mm	✓	✗
D SCW250SBLEM	Bolt Hole	Ø50mm	40kg	68mm	22mm	n/a	Ø10.5mm	20mm	✓	✓
E SCW275SBLEM	Bolt Hole	Ø75mm	60kg	98mm	32mm	n/a	Ø10.5mm	25mm	✓	✓
F SCW2100SBLEM	Bolt Hole	Ø100mm	90kg	131.5mm	35mm	n/a	Ø10.5mm	27mm	✓	✓
G SCW250SPEM	Swivel Plate	Ø50mm	40kg	69.5mm	24mm	60 x 60mm	Ø6.3mm	20mm	✓	✗
H SCW275SPEM	Swivel Plate	Ø75mm	60kg	100mm	28mm	65 x 65mm	Ø6.3mm	25mm	✓	✗
I SCW2100SPEM	Swivel Plate	Ø100mm	90kg	134mm	37mm	76 x 76mm	Ø8.5mm	27mm	✓	✗
J SCW250SPLEM	Swivel Plate	Ø50mm	40kg	69.5mm	22mm	60 x 60mm	Ø6.3mm	20mm	✓	✓
K SCW275SPLEM	Swivel Plate	Ø75mm	60kg	100mm	32mm	65 x 65mm	Ø6.3mm	25mm	✓	✓
L SCW2100SPLEM	Swivel Plate	Ø100mm	90kg	134mm	35mm	76 x 76mm	Ø8.5mm	27mm	✓	✓

M-X Ø100mm Ø125mm Ø160mm Ø200mm 100kg 120kg 250kg 300kg

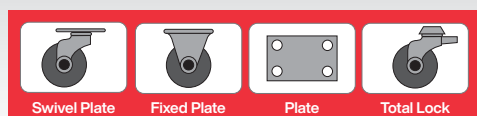

M-X SEE BELOW

Heavy-Duty Blue Elastic Rubber Castor Wheels - Trade

Elastic rubber wheels with nylon core.

Model No.	Fixing Type	Wheel Diameter	Load Capacity	Overall Height	Offset Size	Plate Size	Plate Hole Diameter	Tread Width	Swivel	Total Lock
M SCW3100SPEM	Swivel Plate	Ø100mm	100kg	128mm	39mm	100 x 80mm	Ø9mm	32mm	✓	✗
N SCW3125SPEM	Swivel Plate	Ø125mm	120kg	152mm	36mm	100 x 80mm	Ø9mm	36mm	✓	✗
O SCW3160SPEM	Swivel Plate	Ø160mm	250kg	193mm	57mm	140 x 110mm	Ø11mm	50mm	✓	✗
P SCW3200SPEM	Swivel Plate	Ø200mm	300kg	232mm	62mm	140 x 110mm	Ø11mm	50mm	✓	✗
Q SCW3100SPLEM	Swivel Plate	Ø100mm	100kg	128mm	38mm	100 x 80mm	Ø9mm	32mm	✓	✓
R SCW3125SPLEM	Swivel Plate	Ø125mm	120kg	152mm	34mm	100 x 80mm	Ø9mm	36mm	✓	✓
S SCW3160SPLEM	Swivel Plate	Ø160mm	250kg	193mm	57mm	140 x 110mm	Ø11mm	50mm	✓	✓
T SCW3200SPLEM	Swivel Plate	Ø200mm	300kg	232mm	62mm	140 x 110mm	Ø11mm	50mm	✓	✓
U SCW3100FPPEM	Fixed Plate	Ø100mm	100kg	128mm	n/a	100 x 84mm	Ø9mm	32mm	✗	✗
V SCW3125FPPEM	Fixed Plate	Ø125mm	120kg	152mm	n/a	100 x 84mm	Ø9mm	36mm	✗	✗
W SCW3160FPPEM	Fixed Plate	Ø160mm	250kg	193mm	n/a	146 x 107mm	Ø11mm	50mm	✗	✗
X SCW3200FPPEM	Fixed Plate	Ø200mm	300kg	232mm	n/a	146 x 107mm	Ø11mm	50mm	✗	✗

A-O Ø80mm Ø100mm Ø125mm 150kg 200kg 230kg

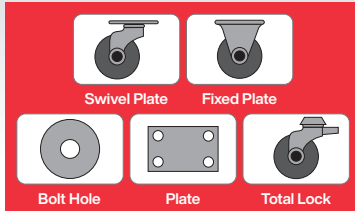

A-O SEE BELOW
Heavy-Duty Nylon
Castor Wheels - Trade

Nylon wheels with cast aluminium core.

A-C

D-F

G-I

J-L

M-O

Model No.	Fixing Type	Wheel Diameter	Load Capacity	Overall Height	Offset Size	Plate Size	Plate Hole Diameter	Tread Width	Swivel	Total Lock
A SCW480SBEM	Bolt Hole	Ø80mm	150kg	108mm	35mm	n/a	Ø12.5mm	30mm	✓	✗
B SCW4100SBEM	Bolt Hole	Ø100mm	150kg	127mm	39mm	n/a	Ø12.5mm	32mm	✓	✗
C SCW4125SBEM	Bolt Hole	Ø125mm	230kg	150mm	35mm	n/a	Ø12.5mm	38mm	✓	✗
D SCW480SBLEM	Bolt Hole	Ø80mm	150kg	108mm	35mm	n/a	Ø12.5mm	30mm	✓	✓
E SCW4100SBLEM	Bolt Hole	Ø100mm	200kg	127mm	38mm	n/a	Ø12.5mm	32mm	✓	✓
F SCW4125SBLEM	Bolt Hole	Ø125mm	230kg	150mm	34mm	n/a	Ø12.5mm	38mm	✓	✓
G SCW480SPEM	Swivel Plate	Ø80mm	150kg	110mm	35mm	100 x 80mm	Ø9mm	30mm	✓	✗
H SCW4100SPEM	Swivel Plate	Ø100mm	200kg	128mm	39mm	100 x 80mm	Ø9mm	32mm	✓	✗
I SCW4125SPEM	Swivel Plate	Ø125mm	230kg	152mm	35mm	100 x 80mm	Ø9mm	38mm	✓	✗
J SCW480SPLEM	Swivel Plate	Ø80mm	150kg	110mm	35mm	100 x 80mm	Ø9mm	30mm	✓	✓
K SCW4100SPLEM	Swivel Plate	Ø100mm	200kg	128mm	38mm	100 x 80mm	Ø9mm	32mm	✓	✓
L SCW4125SPLEM	Swivel Plate	Ø125mm	230kg	152mm	34mm	100 x 80mm	Ø9mm	38mm	✓	✓
M SCW480FPEM	Fixed Plate	Ø80mm	150kg	110mm	n/a	100 x 84mm	Ø9mm	30mm	✗	✗
N SCW4100FPEM	Fixed Plate	Ø100mm	200kg	128mm	n/a	100 x 84mm	Ø9mm	32mm	✗	✗
O SCW4125FPEM	Fixed Plate	Ø125mm	230kg	152mm	n/a	100 x 84mm	Ø9mm	38mm	✗	✗

P-X Ø125mm Ø152mm Ø200mm 250kg 330kg 350kg

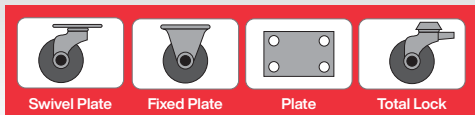

P-X SEE BELOW
Heavy-Duty Rubber Castor Wheels - Trade

Nylon wheels with cast aluminium core.

P-R

S-U

V-X

Model No.	Fixing Type	Wheel Diameter	Load Capacity	Overall Height	Offset Size	Plate Size	Plate Hole Diameter	Tread Width	Swivel	Total Lock
P SCW5125SPEM	Swivel Plate	Ø125mm	250kg	161mm	55mm	140 x 110mm	Ø11mm	50mm	✓	✗
Q SCW5152SPEM	Swivel Plate	Ø152mm	330kg	189mm	57mm	140 x 110mm	Ø11mm	50mm	✓	✗
R SCW5200SPEM	Swivel Plate	Ø200mm	350kg	232mm	62mm	140 x 110mm	Ø11mm	50mm	✓	✗
S SCW5125SPLEM	Swivel Plate	Ø125mm	250kg	161mm	55mm	140 x 110mm	Ø11mm	50mm	✓	✓
T SCW5152SPLEM	Swivel Plate	Ø152mm	330kg	189mm	57mm	140 x 110mm	Ø11mm	50mm	✓	✓
U SCW5200SPLEM	Swivel Plate	Ø200mm	350kg	232mm	62mm	140 x 110mm	Ø11mm	50mm	✓	✓
V SCW5125FPEM	Fixed Plate	Ø125mm	250kg	161mm	n/a	146 x 107mm	Ø11mm	50mm	✗	✗
W SCW5152FPEM	Fixed Plate	Ø152mm	330kg	189mm	n/a	140 x 110mm	Ø11mm	50mm	✗	✗
X SCW5200FPEM	Fixed Plate	Ø200mm	350kg	232mm	n/a	146 x 107mm	Ø11mm	50mm	✗	✗

A-I Ø50mm Ø75mm Ø100mm 40kg 60kg 70kg

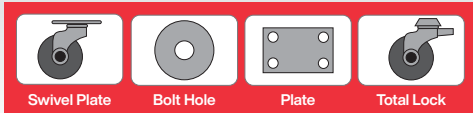

2 YEAR
GUARANTEE*

A-I SEE BELOW

Medium-Duty Polyurethane Castor Wheels - Industrial

Non-marking polypropylene/polyurethane wheels.

Model No.	Fixing Type	Wheel Diameter	Load Capacity	Overall Height	Offset Size	Plate Size	Plate Hole Diameter	Tread Width	Swivel	Total Lock
A SCW250SB	Bolt Hole	Ø50mm	40kg	70mm	25mm	n/a	Ø11mm	19mm	✓	✗
B SCW275SB	Bolt Hole	Ø75mm	60kg	100mm	25mm	n/a	Ø11mm	25mm	✓	✗
C SCW2100SB	Bolt Hole	Ø100mm	70kg	125mm	28mm	n/a	Ø11mm	25mm	✓	✗
D SCW275SBL	Bolt Hole	Ø75mm	60kg	100mm	25mm	n/a	Ø11mm	25mm	✓	✓
E SCW2100SBL	Bolt Hole	Ø100mm	70kg	125mm	28mm	n/a	Ø11mm	25mm	✓	✓
F SCW275SP	Swivel Plate	Ø75mm	60kg	100mm	25mm	60 x 60mm	Ø6.3mm	25mm	✓	✗
G SCW2100SP	Swivel Plate	Ø100mm	70kg	125mm	28mm	77 x 67mm	Ø8.5mm	25mm	✓	✗
H SCW250SPL	Swivel Plate	Ø50mm	40kg	70mm	25mm	60 x 60mm	Ø6.3mm	19mm	✓	✓
I SCW275SPL	Swivel Plate	Ø75mm	60kg	100mm	25mm	60 x 60mm	Ø11mm	25mm	✓	✓

J-U Ø100mm Ø125mm Ø160mm Ø200mm 160kg 250kg 300kg 400kg

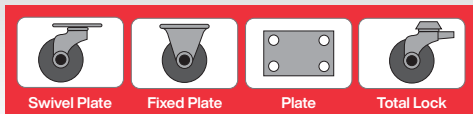

2 YEAR
GUARANTEE*

J-U SEE BELOW

Heavy-Duty Blue Elastic Rubber Castor Wheels - Industrial

Non-marking polyamide/elastic wheels.

Model No.	Fixing Type	Wheel Diameter	Load Capacity	Overall Height	Offset Size	Plate Size	Plate Hole Diameter	Tread Width	Swivel	Total Lock
J SCW3100SP	Swivel Plate	Ø100mm	160kg	128mm	41mm	105 x 85mm	Ø9mm	34mm	✓	✗
K SCW3125SP	Swivel Plate	Ø125mm	250kg	155mm	40mm	105 x 85mm	Ø9mm	40mm	✓	✗
L SCW3160SP	Swivel Plate	Ø160mm	300kg	200mm	55mm	137 x 105mm	Ø11mm	46mm	✓	✗
M SCW3200SP	Swivel Plate	Ø200mm	400kg	240mm	55mm	137 x 105mm	Ø11mm	46mm	✓	✗
N SCW3100SPL	Swivel Plate	Ø100mm	160kg	128mm	41mm	105 x 85mm	Ø9mm	34mm	✓	✓
O SCW3125SPL	Swivel Plate	Ø125mm	250kg	155mm	40mm	105 x 85mm	Ø9mm	40mm	✓	✓
P SCW3160SPL	Swivel Plate	Ø160mm	300kg	200mm	60mm	137 x 105mm	Ø11mm	46mm	✓	✓
Q SCW3200SPL	Swivel Plate	Ø200mm	400kg	240mm	55mm	137 x 105mm	Ø11mm	46mm	✓	✓
R SCW3100FP	Fixed Plate	Ø100mm	160kg	128mm	n/a	103 x 85mm	Ø9mm	34mm	✗	✗
S SCW3125FP	Fixed Plate	Ø125mm	250kg	155mm	n/a	103 x 85mm	Ø9mm	40mm	✗	✗
T SCW3160FP	Fixed Plate	Ø160mm	300kg	200mm	n/a	137 x 115mm	Ø11mm	46mm	✗	✗
U SCW3200FP	Fixed Plate	Ø200mm	400kg	240mm	n/a	137 x 115mm	Ø11mm	46mm	✗	✗

A-K Ø80mm Ø100mm Ø125mm 125kg 150kg 200kg 250kg

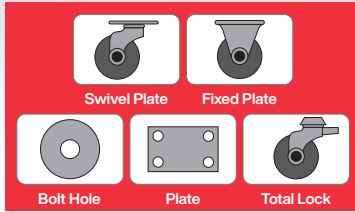

A-B

C-E

F-H

I-J

K

2 YEAR
GUARANTEE*

A-K SEE BELOW
Heavy-Duty Nylon
Castor Wheels - Industrial
Non-marking polyamide wheels.

Model No.	Fixing Type	Wheel Diameter	Load Capacity	Overall Height	Offset Size	Plate Size	Plate Hole Diameter	Tread Width	Swivel	Total Lock
A SCW480SB	Bolt Hole	Ø80mm	125kg	108mm	40mm	n/a	Ø13mm	34mm	✓	✗
B SCW4100SB	Bolt Hole	Ø100mm	150kg	128mm	40mm	n/a	Ø13mm	36mm	✓	✗
C SCW480SBL	Bolt Hole	Ø80mm	150kg	108mm	44.5mm	n/a	Ø13mm	34mm	✓	✓
D SCW4100SBL	Bolt Hole	Ø100mm	150kg	128mm	41mm	n/a	Ø13mm	36mm	✓	✓
E SCW4125SBL	Bolt Hole	Ø125mm	150kg	155mm	40mm	n/a	Ø13mm	40mm	✓	✓
F SCW480SP	Swivel Plate	Ø80mm	200kg	108mm	40mm	105 x 85mm	Ø9mm	34mm	✓	✗
G SCW4100SP	Swivel Plate	Ø100mm	200kg	128mm	41mm	105 x 85mm	Ø9mm	36mm	✓	✗
H SCW4125SP	Swivel Plate	Ø125mm	250kg	155mm	40mm	105 x 85mm	Ø9mm	40mm	✓	✗
I SCW4100SPL	Swivel Plate	Ø100mm	200kg	128mm	41mm	105 x 85mm	Ø9mm	36mm	✓	✓
J SCW4125SPL	Swivel Plate	Ø125mm	250kg	155mm	40mm	105 x 85mm	Ø9mm	40mm	✓	✓
K SCW4100FP	Fixed Plate	Ø100mm	200kg	128mm	n/a	103 x 85mm	Ø9mm	36mm	✗	✗

L-Q Ø125mm Ø160mm Ø200mm 500kg 600kg

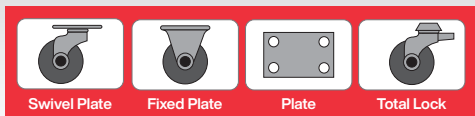

L-N

O-P

Q

2 YEAR
GUARANTEE*

L-Q SEE BELOW
Ultra-Heavy-Duty Polyurethane
Castor Wheels - Industrial
Non-marking aluminium/polyurethane wheels.

Model No.	Fixing Type	Wheel Diameter	Load Capacity	Overall Height	Offset Size	Plate Size	Plate Hole Diameter	Tread Width	Swivel	Total Lock
L SCW5125SP	Swivel Plate	Ø125mm	500kg	164mm	55mm	137 x 105mm	Ø11mm	50mm	✓	✗
M SCW5160SP	Swivel Plate	Ø160mm	600kg	200mm	55mm	137 x 105mm	Ø11mm	50mm	✓	✗
N SCW5200SP	Swivel Plate	Ø200mm	600kg	240mm	55mm	137 x 105mm	Ø11mm	50mm	✓	✗
O SCW5125SPL	Swivel Plate	Ø125mm	500kg	164mm	55mm	137 x 105mm	Ø11mm	50mm	✓	✓
P SCW5160SPL	Swivel Plate	Ø160mm	600kg	200mm	60mm	137 x 105mm	Ø11mm	50mm	✓	✓
Q SCW5125FP	Fixed Plate	Ø125mm	500kg	164mm	n/a	137 x 105mm	Ø11mm	50mm	✗	✗