



MULTIPURPOSE MOBILE LIFT &
SUITABLE FOR EV BATTERIES

BATPRO



1200 KG

2500 KG

LIFTING
CAPACITY



CELETTE®

For enquiries please write to: info@celette.com

The ALL NEW CELETTE BATPRO is a portable full-rise X-lift table that is perfect for EV battery pack replacement. This space-saving scissor lift is ideal for handling EV batteries effectively because of its small size and mobility throughout the workshop.

To elevate, lower, and move objects like a high voltage electric vehicle (EV) battery, an engine, a transmission, a fuel tank, or an axle.

- Transporting items from one place to another is made easy by their portable design.
- For secure handling of batteries, a range of lifting brackets are accommodated by uniform mounting holes on the top surface.
- Low rolling resistance and easy manoeuvrability are delivered by a steering arm of the pallet-jack type.
- A typical hand pendant station that enables users to remotely control the lift during all lifting activities.
- Mechanism for tilting the top surface forward, backward, and sideways to more precisely align the electric batteries.

TECHNICAL DATA	BAT22.1200.x	BAT22.2500.x
Input Supply Voltage	220/230 V 50/60 Hz	220/230 V 50/60 Hz
Lifting Capacity	1200 kg / 2645 lbs	2500 kg / 5511 lbs
Max Height	1790 mm / 70.4 in	
Min Height	850 mm / 33.4 in	
Length	2400 mm / 94.4 in	
Width	900 mm / 35.4 in	
Ground Clearance	183 mm	
CYCLE TIME Raising (Normal Speed) with rated Load Raising (Slower Speed) with rated Load Lowering with rated Load	MEASUREMENTS Approx. 44 sec Approx. 96 sec Approx. 55 sec	
Hydraulic Pressure	18 MPa	26 MPa
Oil Tank Capacity	4 litres	5 litres



SPIRIT LEVEL:
Visualize the angle of tilt to avoid excess tilting with load. It can be used to level the top plate horizontally to gravity.

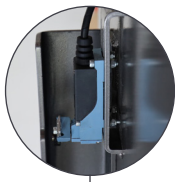

LIMIT SWITCH:
Restricts the lift to rise beyond maximum height.



REMOTE CONTROLLER:
Dual speed control for easy alignment.

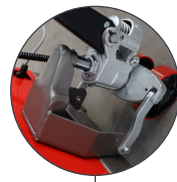

TOWING JACK:
Helps in the mobility of the lift. It also serves as a braking mechanism when the towing jack is not engaged.

SPECIAL FEATURES

THREADED HOLES:
Multiple mounting options for different battery sizes.

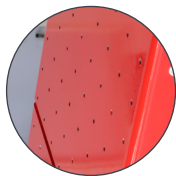

EXPANDABLE LENGTH:
Adjust the length upto 250 mm for extra long battery.

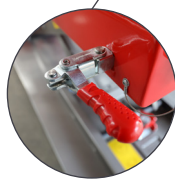

TOGGLE CLAMP:
To move & lock the lift sideways by 20 mm.



MECHANICAL SAFETY LOCK:
Engage to bring the lift to a complete safe position for maintenance.



WHEEL GUARD:
Heavy duty wheel with foot protection.



PRESSURE SWITCH:
Detects overload on the lift and stops the operation of the lift, until the excess load is removed from the lift.



MINUTE TILTING AND SLIDING ADJUSTMENT UPTO 20 MM
When the car is not aligned parallel to the floor, tilt the lift to align it accordingly to the car body.



NON-RETURN VALVE:
Restricts unintentional flow of oil out of the cylinder. Acts as an additional safety mechanism.

PRODUCT DIMENSIONS

TOP VIEW

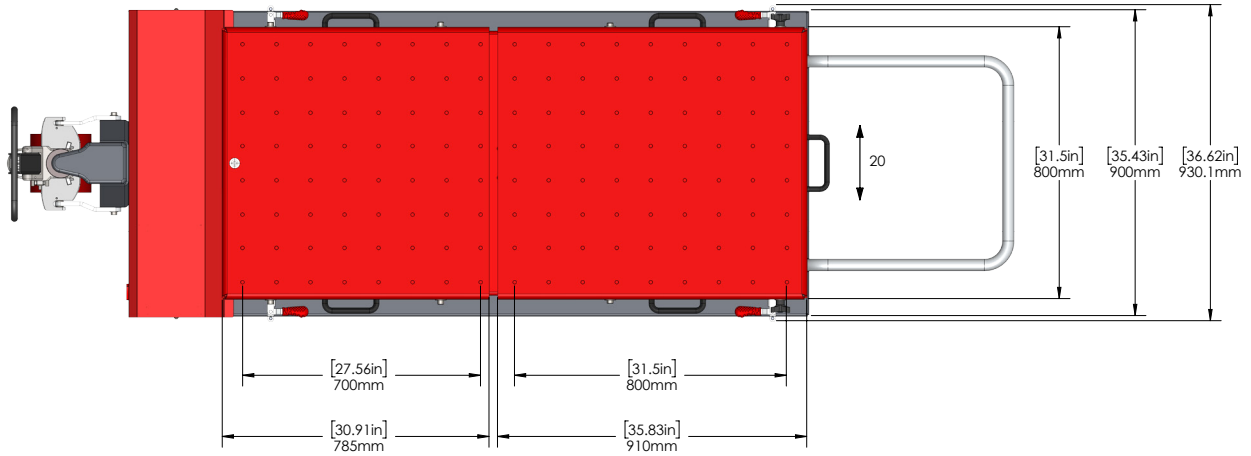

SIDE VIEW

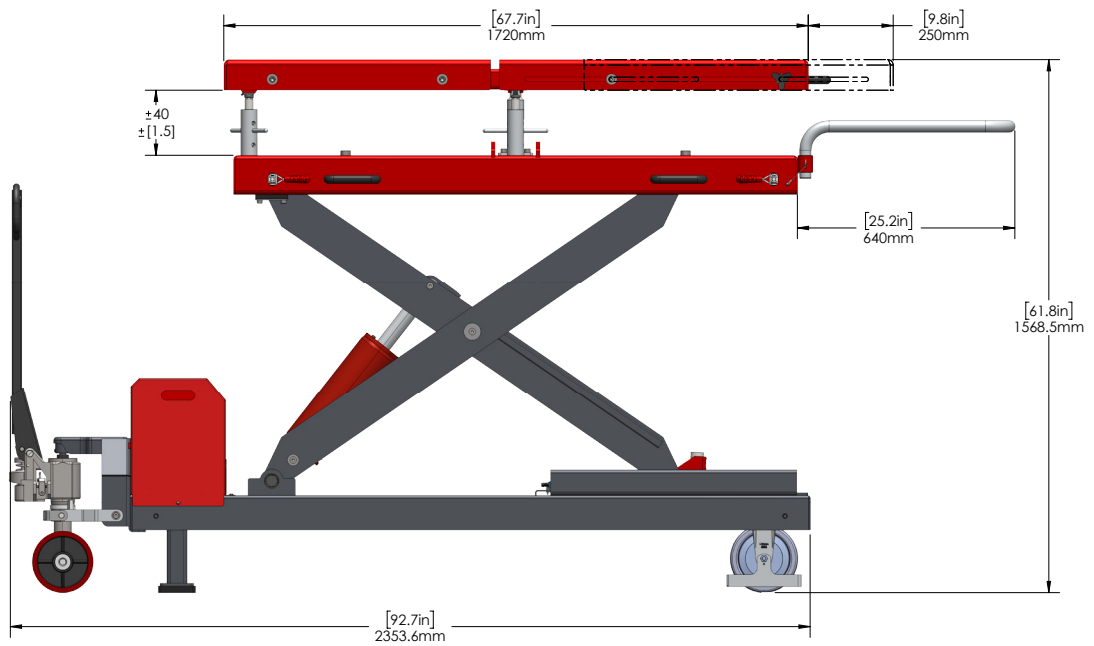

FRONT



REAR



FRONT



REAR





CELETTE

3, AVENUE MARCELLIN BERTHELOT
38200 VIENNE / FRANCE
☎ +33 474 575 959



CELETTE DEUTSCHLAND GMBH

EUGEN-ENSSLIN-STR.3 77694 KEHL
GERMANY
☎ +49 785 195 53 712



CELETTE NORTH AMERICA

700/122 VALLEY RIDGE BLVD.LEWISVILLE,
TX 75057 / USA
☎ +1 254 382 8698



CELETTE INDIA PVT LTD.

2/122 B-1, MYLAMPATTY ROAD,
KARAYAMPALAYAM,
COIMBATORE 641062 / INDIA
☎ +91 88 70 86 11 11



**CELETTE AUTO EQUIPMENT
AND REPAIRATION**

ROOM 3, 11F, XING HUI BUILDING,
NO 176, MIN YANG ROAD,
JIAXING, 31400 ZHEJIANG PROVINCE / CHINA
☎ +86 158 8831 7667



CELETTE JAPAN TECHNICAL OFFICE

667-9 MABASHI, SHISUI-MACHI, INBA-GUN,
CHIBA 285-0914 / JAPAN
☎ +81 70 2183 1960



CELETTE ASIA PACIFIC

700/941 M,5 AMATA CITY
CHONBURI INDUSTRIAL ESTATE,
NONGKAKHA, PHANTHONG 20160
CHONBURI / THAILAND
☎ +66 905 630 258

DISTRIBUTED BY

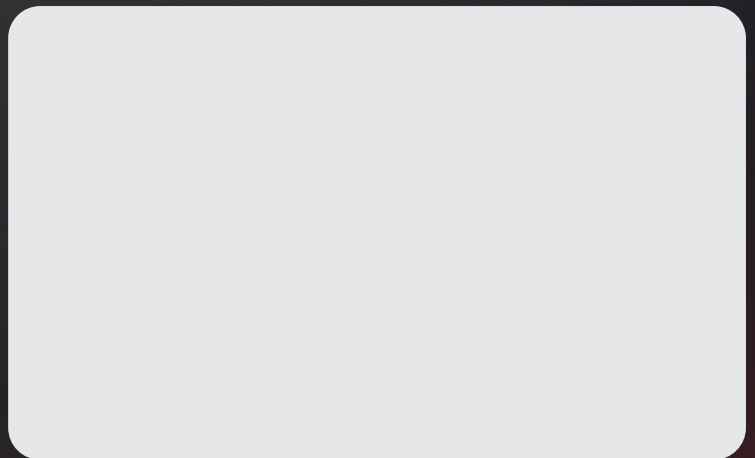

✉ info@celette.com | 🌐 www.celette.com

